

## PRODUCT FEATURES:

- Smart-Play Integration system allows connection of Android and other smartphones to the Chrysler infotainment system.
- Made for Android Auto and CarPlay.
- Adds front and rear aftermarket camera inputs.
- Retains functionality of the OEM backup camera if present.
- Front camera automatically shows on the screen after changing the gear from reverse to drive.
- Forced view of front camera capability.

## PARTS INCLUDED:



ACPCH-01 Module



Power Harnesses



Smartphone Interface Module

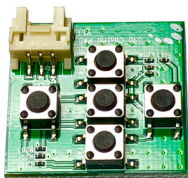

OSD Controller



4K HDMI Cable



Microphone



LVDS Video Cable



3.5mm Aux Cable



Smart-Play Module Power Harness



**WIRING DIAGRAM:**

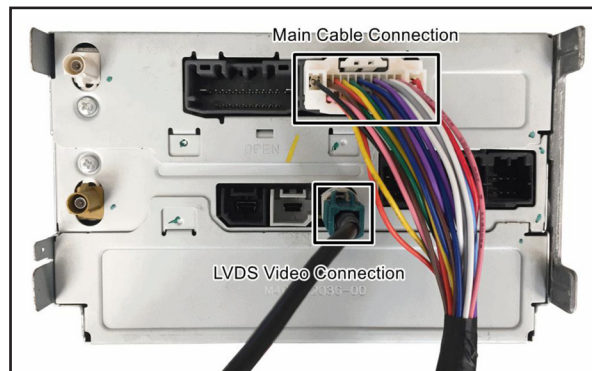
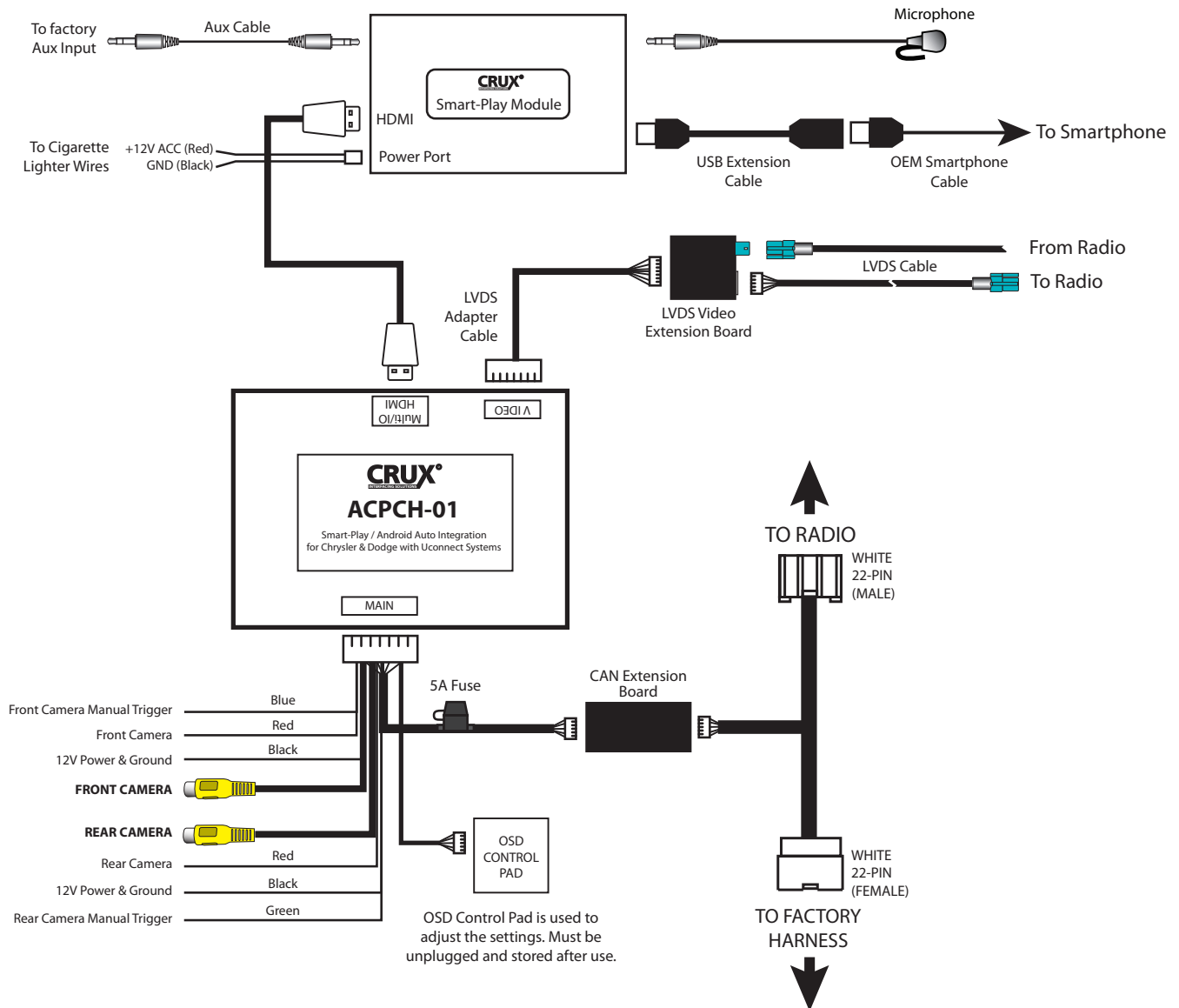

**DIP SWITCH SETTINGS:**



Note: ON is down and OFF is up



8.4" Screen



4" Screen



**INSTALLATION INSTRUCTIONS:**



1. Use a panel removal tool to remove the left and right side trims.



2. Remove the 2 T20 torx screws.



3. Gently pull out the control panel.



4. Unplug the connector.



5. Remove the 4 T20 screws.



6. Unplug the radio connector and plug it to the T-harness. Plug the other end of the t-harness to the radio.

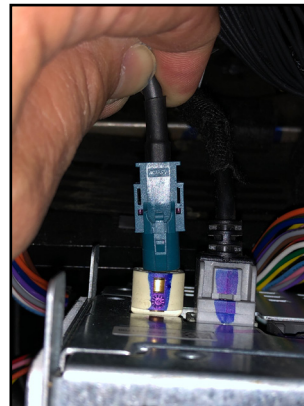

7. Unplug the factory LVDS connector and plug it to the LVDS video board. Plug the LVDS connector from the LVDS video board to the radio.

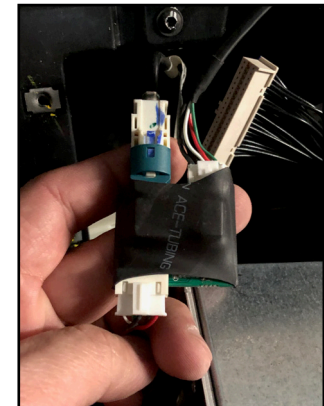



8. Plug in the main harness to the ACPCH-01 module.

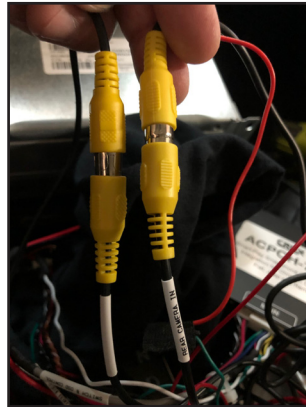

9. Plug in the camera RCAs to be used and tap the power to the camera power wires.

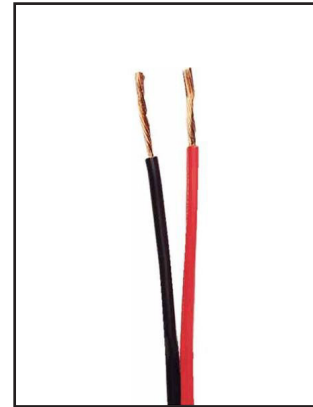

10. Tap the Smart-Play power and ground wires to the cigarette lighter wires.



11. Plug in the power plug, 4K HDMI cable and the 3.5mm Aux cable to the Smart-Play module. Run the 3.5mm Aux cable to the factory Aux input location



12. Plug in the USB extension cable and mic to the Smart-Play module. Run the USB extension cable to an accessible location. Run the mic cable to the A pillar.



13. Plug in the Aux cable to the factory Aux input port. Possible location of this port is in the center console.

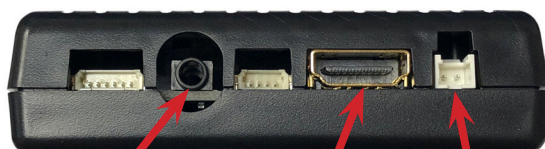

Line Out (Aux)

HDMI

Power Port



USB

Mic In



**ON SCREEN DISPLAY (OSD) SETTINGS:**

The OSD Setting Screen automatically pops up when the OSD Control Pad is connected.



Use the OSD menu to make the necessary settings. Remember to Run **Save&Reboot** after the settings are made. Unplug the OSD Control Pad after setting the cameras and keep it in a secure location in case it is needed to change the settings.

**SMART-PLAY SETTING**

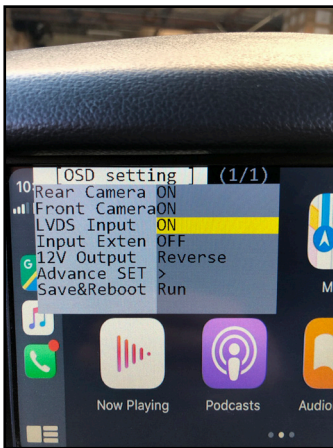

After plugging in the OSD controller, navigate down to **LVDS Input** and set to ON. Push RIGHT button to go to the next menu.

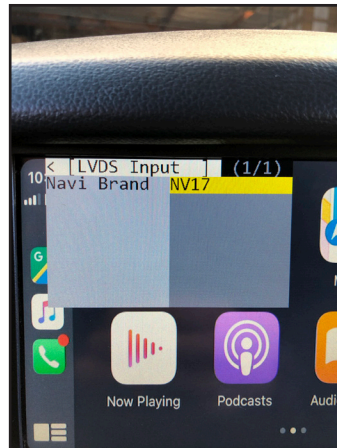

Set **Navi Brand** to **NV17**

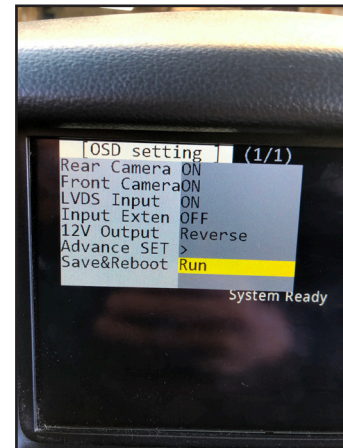

Navigate the OSD back the main menu and go to **Save&Reboot** then **Run**.



**REAR AND FRONT CAMERA SETTING**

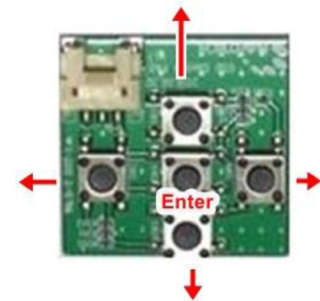
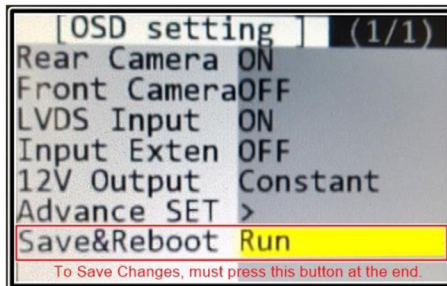
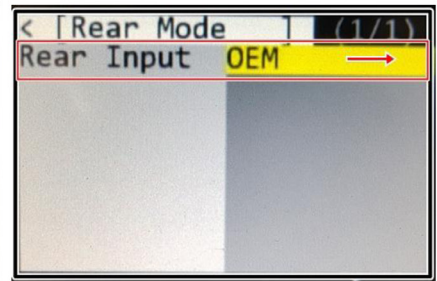
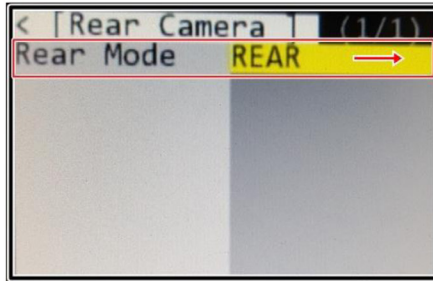
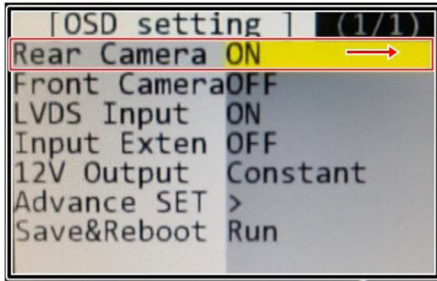

**Dynamic Parking Guide Lines**

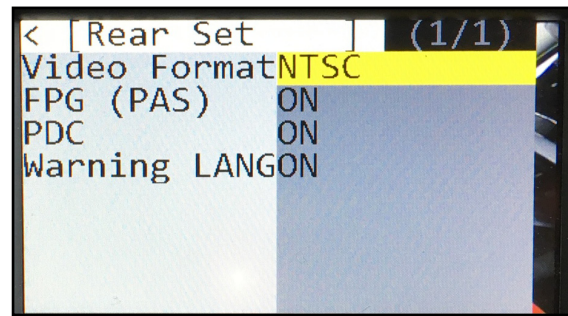
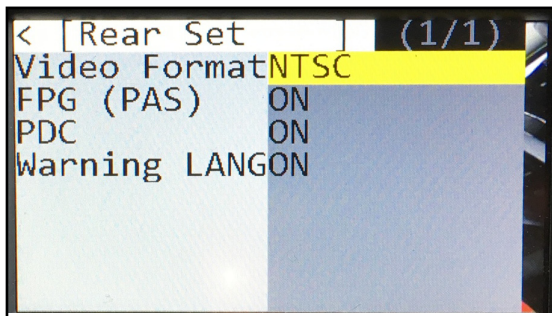

To turn ON the Dynamic Parking Guide Lines, go the Rear Input > Rear Set and turn ON Warning LANG. Go back to the root menu and Run Save&Reboot. Remember to unplug the OSD Control Pad otherwise the unit will not function properly. Set the parking brake on, start the car, put the gear in reverse, turn the steering wheel all the way to the left and all the way to right then put it in the center. The ACPCH-01 will calibrate automatically.

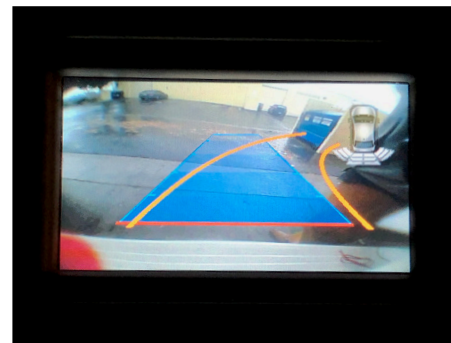

**FRONT CAMERA SETTING**

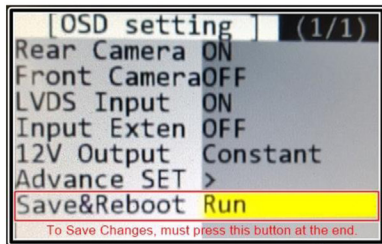
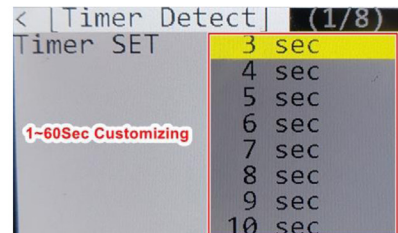
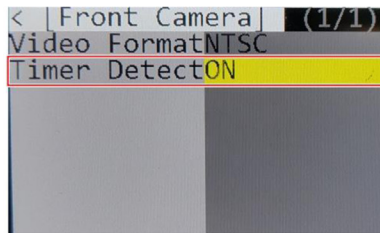
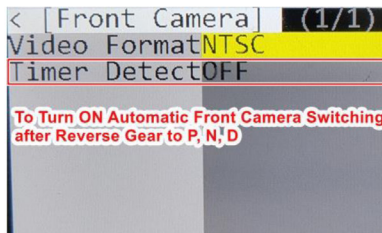
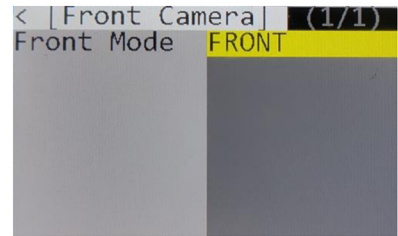
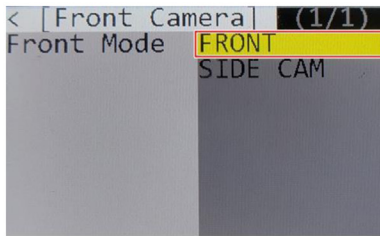
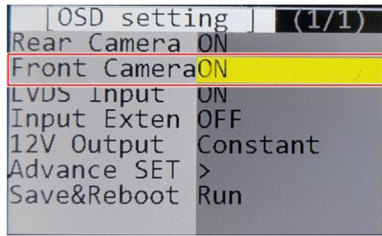

The front Camera will automatically show on the screen when the gear is put to Drive from Reverse. Set the delay time on the OSD menu. Delay time can be set from 1 to 60 seconds after a putting the car to drive from reverse.

**SMART-PLAY CONTROLS SETTING**



Menu Button

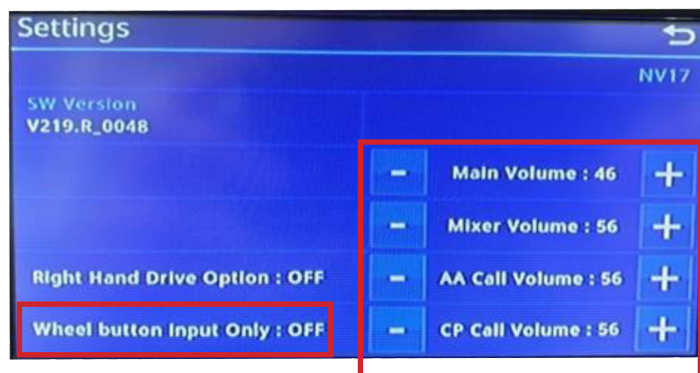

While in Smart-Play screen, press the Menu button for 3 seconds to show the Smart-Play setting screen. For vehicles WITHOUT factory touch screen, set Wheel button Input Only: to ON. Smart-Play (CP), Android Auto (AA) and Main Volume can also be adjusted in this menu.



## AUDIO INPUT TO VEHICLE:



Plug the 3.5mm Aux cable to the factory Aux input.



Set the headunit source to AUX Device

## OPERATION:

To toggle between Smart-Play and OEM screen mode, use the controls below:



On the steering wheel controls:  
Press and hold the BACK button for 3 seconds.



On the factory screen: Press and hold the upper left corner of the screen.



On the Smart-Play screen: Press and hold the upper left corner of the screen.





Smart-Play home screen. Use the factory touch screen for Smart-Play controls.

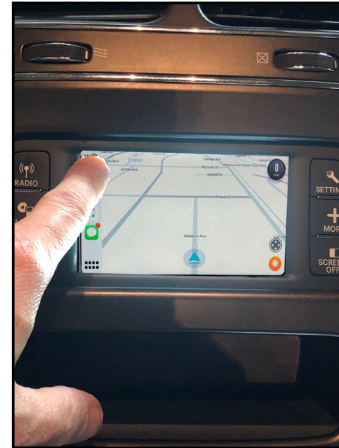

Apps can be opened and controlled by touch screen or by voice control.

**FORCE VIEWING THE FRONT CAMERA:**

To force view the front camera, tap the “Front Camera Manual Trigger” wire (Blue) to +12V. Use a toggle switch (not included) to switch on or off. See diagram on page 2.



**VEHICLE APPLICATIONS:**

Compatible with Uconnect Systems

**CHRYSLER**

2011 - 2014 300 (8.4” or 4.3” Screen)

**DODGE**

2011 - 2014 Charger (8.4” or 4.3” Screen)  
2015 Challenger (8.4” or 4.3” Screen)  
2011 - 2017 Journey (8.4” or 4.3” Screen)

**FIAT**

2011 - 2014 Freemont (4.3” Screen)

**MASERATI**

2014 - 2017 Ghibli (4.3” Screen)  
2014 - 2017 Quattroporte (4.3” Screen)

