



BE9ACP USER MANUAL

Apple CarPlay® & Android Auto™ (Wired)
BLUETOOTH® | 340 WATTS | MP3-COMPATIBLE
DIGITAL MEDIA AM/FM RECEIVER
FEATURING 9" (229 mm) CAPACITIVE TOUCHSCREEN
AND MULTICOLOR ILLUMINATION OPTIONS





Thank you for choosing BOSS Audio Systems!

Sign up for BOSS Audio Systems News and Promos by visiting us on the web at www.bossaudio.com.

Be part of our community! Join us by signing up on the web at www.bossinsiders.com

<i>IMPORTANT! Complete the information below and keep for your records.</i>	
Model	
Serial Number	
Date of Purchase	
<i>Note: Serial number is located on the packaging and the top of the product chassis.</i>	

Table of Contents

Important Information	4
About this Manual.....	4
Operation Warnings	4
Installation Warnings	5
Screen Care.....	5
Notice	5
Basic Operation	6
What Comes in the Box	6
Control Panel.....	7
Unit Installation.....	8
Home Menu Description	12
Basic Setup.....	13
FM/AM Radio	14
Radio Home Screen	14
Tune to a Radio Station	14
Auto Store Radio Stations	14
Select a Stored Station	14
Set a Favorite Station	14
FM Local and Distant.....	14
FM Stereo and Mono.....	14

Apple CarPlay	15
Apple CarPlay Introduction	15
Connect your iPhone	15
Arrange your CarPlay Apps.....	16
Disable CarPlay Apps	16

Android Auto	17
Android Auto Introduction	17
Connect your Android Device	17

Bluetooth	18
First Time Connection.....	18
Audio Streaming.....	18
Make a Call.....	19
Operation During a Call	19
Sync Phonebook and History.....	19
Search a Contact.....	19
Browse Call History	19
View Connection Status.....	19
Voice Assistant (Push-To-Talk)	19

USB	20
USB Playback.....	20
Audio/Video/Photo Play Switching	20
Audio Playback.....	20
Video Playback	20
Photo Playback.....	20

Other External Devices	21
Audio/Video Input	21
Playback.....	21
Audio Input.....	21
Video Input	21
Manual Camera Trigger.....	21
Automatic Camera Trigger	21

General Settings	22
Language Setting.....	22
Set Date and Time	22
System Tone and Shutdown Delay	22
Resetting the Unit.....	22
Startup Message Display	22

Table of Contents

Audio Settings 22

Volume Balance Setting	22
Subwoofer Setting	23
Loudness and Sound Mode Setting	23
Internal Amplifier On/Off	23
Startup Volume Setting.....	23
Initial Volume Setting for Other Sources	23
Customization of a Source Volume.....	23

Display Settings 24

Automatic Dimming Control	24
Screen Setting	24
Panel Button Light Setting	24
Wallpaper Setting.....	24

Bluetooth Settings 24

Camera Settings 25

Camera Trigger Control	25
Parking Assist Guidelines Setting	25

Radio Settings 26

Radio Region Selecting	26
RDS/RBDS Activation	26
RDS/RBDS Traffic Announcement	26
RDS/RBDS Alternative Frequency.....	26

System Information 26

Firmware Version Information	26
------------------------------------	----

SWC Retention 26

Steering Wheel Control Retention	26
----------------------------------------	----

Connections 27

Power and SWC Wiring.....	27
Speaker Wiring	28
Parking Brake Wiring	29
AV/Radio.....	30
Mic/Camera/CarPlay/Android Auto.....	31
Hands-Free Mic Installation.....	32

Troubleshooting 33

Specifications 34

Important Information

About this Manual

To understand how to properly use your new BOSS Audio Systems product, it is recommended to read this user manual in its entirety, and keep it in a safe place for future reference.

This manual uses illustrations to show you how to use this product safely and alert you to potential dangers resulting from improper connections and operation. It is important to fully understand the meaning of each one of these illustrations in order to use this manual and system properly.



The **WARNING** illustration denotes very important instructions. Failure to follow them can result in damage to equipment, serious injury or death.



The **CAUTION** illustration denotes important instructions. Failure to follow them can result in injury or material property damage.



The **IMPORTANT NOTE** illustration denotes important instructions for product features and limitations. Failure to follow them will result in product misuse and/or unexpected behavior.



The **PARKING BRAKE** illustration denotes features that can only be used with vehicle not in motion and parking brake engaged. Failure to follow them will result in product misuse and/or unexpected behavior.

Operation Warnings



OPERATION OF THIS PRODUCT WHILE DRIVING IS DANGEROUS.

Users should come to a complete stop and in a safe location before using any feature that requires extended periods of time.

PAY ATTENTION TO ROAD CONDITIONS.

Avoid operating product under dangerous road conditions and abide by regulations over information contained on the map display. Follow traffic restrictions and circumstances while driving.

OPERATE AT SAFE VOLUME LEVELS.

Excessive volume levels may obstruct sounds such as emergency vehicle sirens or road warning signals; can be dangerous and may result in an accident. Listening at high volume levels can also cause hearing damage.

DO NOT WATCH VIDEO WHILE DRIVING.

Watching video content may distract the driver from looking ahead of the vehicle and can potentially cause an accident.

Important Information

Installation Warnings

CERTIFIED PROFESSIONAL INSTALLATION.

Installation and service repair of this product by anyone without professional training and experience in consumer electronics and mobile vehicle accessories may be dangerous and result in electric shock, injury or other hazards.

DISCONNECT BATTERY.

To avoid potential shorts in the electrical system, be sure to disconnect the **NEGATIVE (-)** terminal cable before beginning this product installation. Failure to do so may result in electric shock, fire, damage to product and/or property damage.

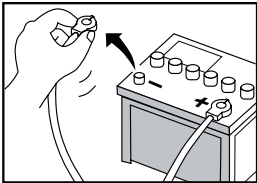

DO NOT DISASSEMBLE OR ALTER PRODUCT.

Disassembly of product may result in an accident, fire or electric shock.

REPLACE FUSE WITH THE CORRECT RATING.

Failure to do so may result in fire or property damage.

PARKING BRAKE INSTALLATION WIRING.

Installing this product incorrectly may enable the user to watch video while driving. This may cause distraction, preventing the driver to focus on the road and potentially cause an accident. The driver and passengers can be severely injured.



Screen Care

USE

This head unit utilizes a Capacitive Touchscreen, the same type that is used on high-end mobile devices. It should be used for and cared for like that type of device. As with all capacitive type technology, if your fingers are wet or sweaty, it will not function properly.

Do not allow any sharp objects to come in contact with the screen.

CLEANING

To clean the screen, use a dry or slightly damp micro fiber type cloth to clean. Do not use ammonia, window cleaner, or any other type of household chemicals to clean the screen. Abrasives should never be used.

Best to clean the screen when the unit is powered off, cool and not in direct sunlight.

Notice



Apple CarPlay is a trademark of Apple Inc.

iPhone® is a trademark of Apple Inc., registered in the U.S. and other countries.

Use of the Apple CarPlay logo means that this user interface meets Apple performance standards.

Apple is not responsible for the operation of this device or its compliance with safety and regulatory standards.

BOSS Audio Systems is not affiliated with Apple Inc.



Android Auto is a trademark of Google LLC.



The Bluetooth® word mark and logos are registered trademarks owned by Bluetooth SIG, Inc. and any use of such marks by BOSS Audio Systems are under license. Other trademarks and trade names are those of their respective owners.

Basic Operation

What Comes in the Box

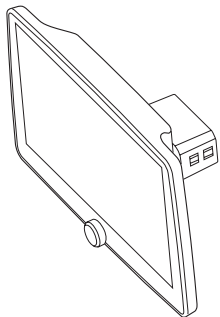

Display

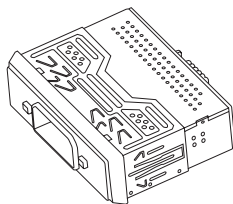

Main Unit

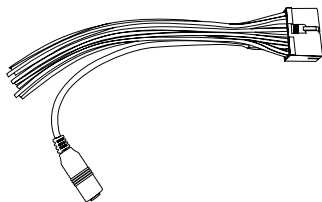

Wiring Harness

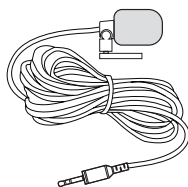

Microphone with 3.5mm Plug
and Sticky Base

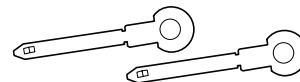

2x Release Keys

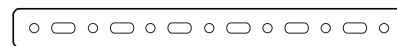

1x Mounting Strap



1x Hex Bolt



1x Hex Nut



2x Plain Washers



1x Tapping Screw



1x Spring Washer



1x Rubber Grommet

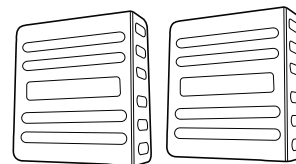

2x Side Brackets



8x Screws

Basic Operation

Control Panel

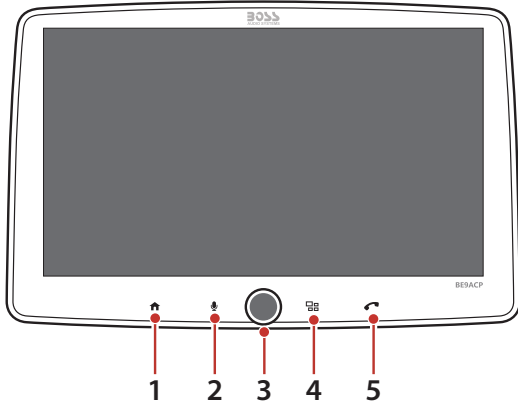

1 Home button

- Touch to switch between the home menu and the last selected source.
- When powered on, touch and hold to turn the screen off.

2 Voice assistant (Push-To-Talk)

Touch to activate voice assistant.

Enable Apple CarPlay, Android Auto or Bluetooth connection to use voice assistant.

3 Power/Mute button

- Press to power on the unit; press and hold to power off the unit.
- Rotate to adjust volume.
- Press to mute or restore the volume when powered on.

4 Mode button

Touch to select a source (Radio, USB, CarPlay/Android Auto, Bluetooth, AUX/AV input).

5 Phone button

Touch to answer a phone call, or dial a Bluetooth phone call.

6 Reset button

Use a needle or pin to press the button. Reset the unit if the unit fails to function normally.

TIP:

When the unit is powered off, touch the screen to turn on or off time/date display.

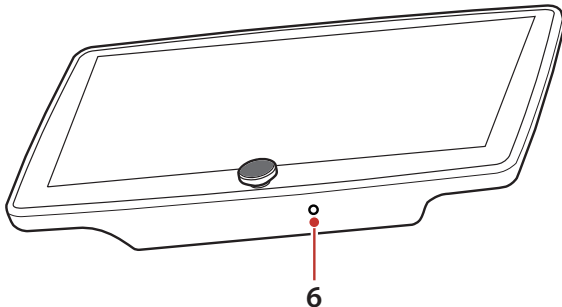

Basic Operation

Unit Installation



WARNING

See the section "Installation Warnings". (P.5)

Single DIN Opening Installation

This section explains the installation if your vehicle has a single DIN opening (2" x 7").

1. Remove the trim plate from the front panel.
Use a screwdriver to pry open the trim plate.
2. Remove the mounting sleeve from the unit.
Insert the two supplied release keys into the locking tabs on both sides of the unit, then pull the mounting sleeve off.

Then secure the mounting sleeve to the dash opening. Bend the tabs on the mounting sleeve to lock the sleeve into place.

3. Insert the unit into the dash opening/
mounting sleeve.
4. Secure the supplied metal strap to the rear of the unit to provide extra fastening (if your car does not have a rear bracket to fix the unit).
Use the supplied hex bolt, hex nut (a), spring washer (b), plain washer (c), tapping screw to fix the metal strap.
Replace the trim plate after the installation.

Before you mount the unit into the dash, complete the wiring connection (P. 28 to 33).

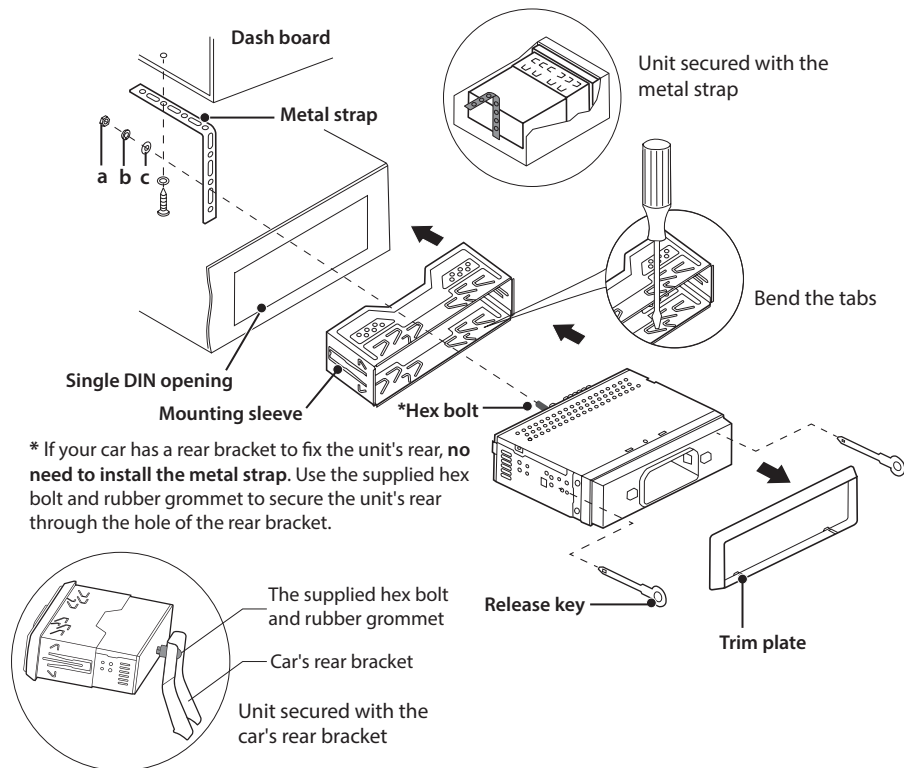

Basic Operation

Unit Installation

Double DIN Opening Installation

This section explains the installation if your vehicle has a double DIN opening (4" x 7").

1. Remove the trim plate and the mounting sleeve from the unit, as described in the section "Single DIN Opening Installation".
2. Using two supplied side brackets and screws, fasten the unit to the double DIN opening. Replace the trim plate after the installation.

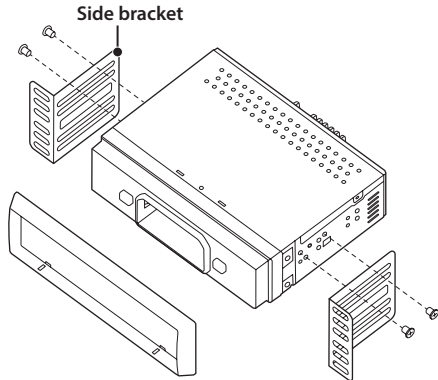

Attach the Display

As illustrated below, insert the supplied display into the head unit until it clicks.

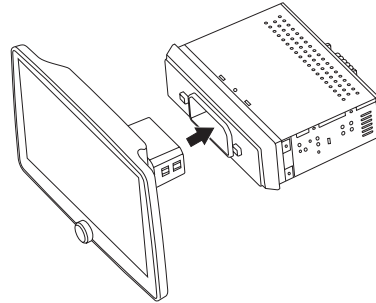

Detach the Display

As illustrated below, hold down two release buttons simultaneously to unlock the display then pull the display out.

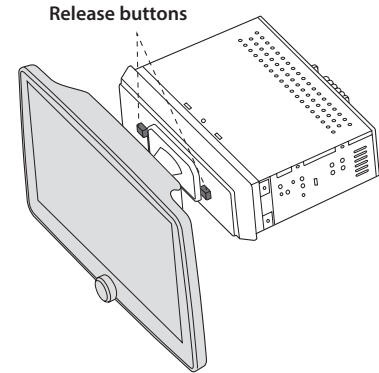

Basic Operation

Unit Installation

Adjust positioning of the Display

Adjust the display angle so that your view is clear and it does not impair your driving.

Adjust the Display Height

Hold the display then slide it up or down to adjust the height.

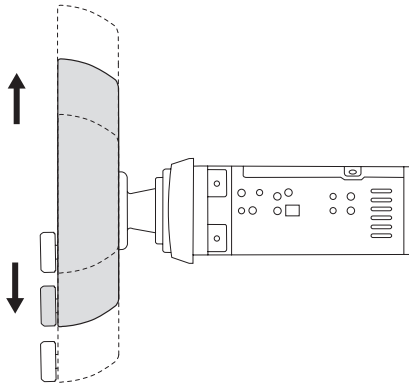

Tilt the Display Up and Down

The display can be vertically tilted by 25 degrees.

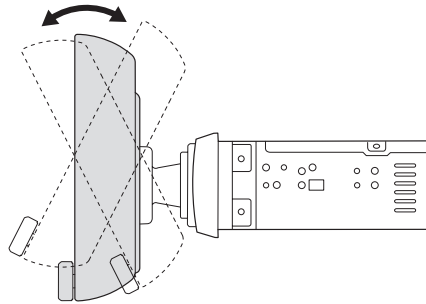

Tilt the Display Left and Right

The display can be horizontally tilted by 15 degrees.

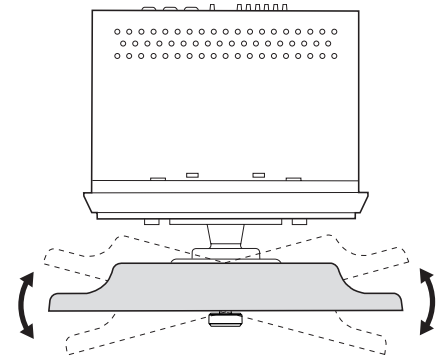

Basic Operation

Unit Installation

Installation Dimensions

Unit Dimensions

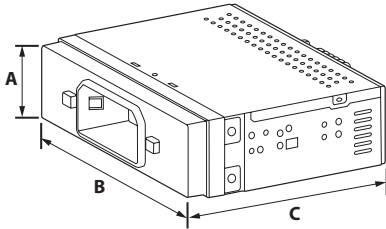

A: 1.97" (50 mm)

C: 5.63" (143 mm)

B: 7" (178 mm)

Display Dimensions

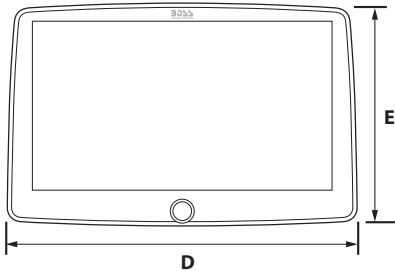

D: 9.29" (236 mm)

E: 5.91" (150 mm)

Display Mounting Dimensions

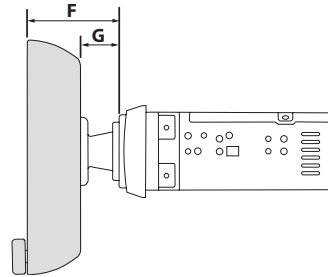

F: 2.48" (63 mm)

G: 1.18" (30 mm)

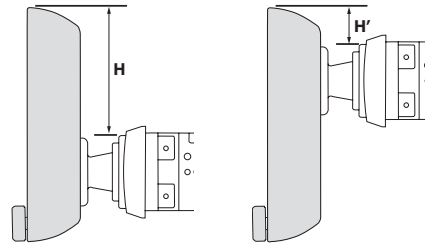

H (at highest position): 3.23" (82 mm)

H' (at lowest position): 1.46" (37 mm)



I (with maximum tilting angle at highest position): 0.51" (13 mm)

I' (with maximum tilting angle at lowest position): 1.26" (32 mm)

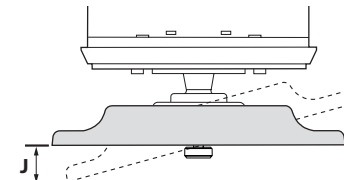

J (with maximum tilting angle): 1.14" (29 mm)

Basic Operation

Home Menu Description

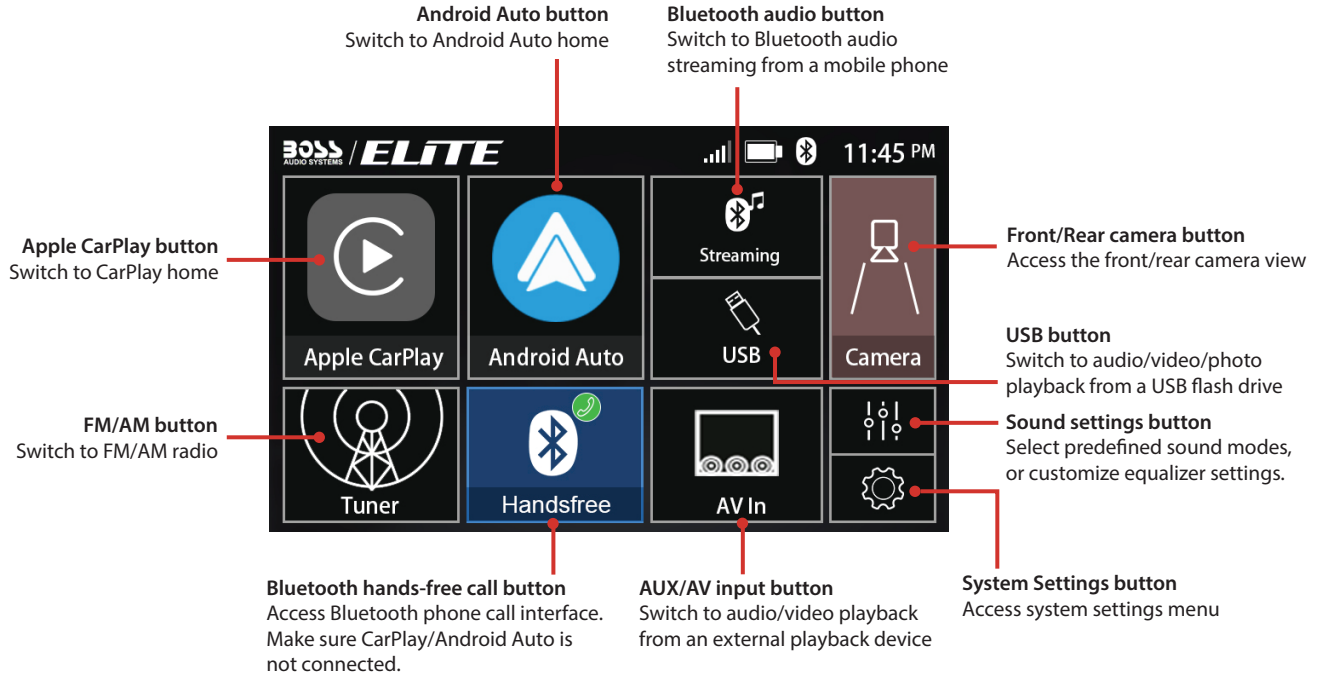

Basic Operation

Basic Setup

Set Language

You can select English or Spanish as a display language for menu.

1. From the home menu, touch  to access system settings.
2. Select [General] > [Language].

Set Clock

Option 1: Automatic Setup

Connect your iPhone to the unit's rear USB port (labeled "Apple CarPlay/Android Auto") to enable Apple CarPlay.

Then the clock will automatically syn with your iPhone.

To change time zone

From the home menu, touch  > [General] > [Time Zone].

The default time zone is Pacific Time.

Option 2: Manual Setup

1. From the home menu, touch  to access system settings.

2. Select [General] > [Date & Time] to access the following date and time options. Touch \wedge or \vee to change settings.

- Select 12 or 24 hour format
- Set month, day and year
- Set hours, minutes and AM/PM

To change time zone

Access [Time Zone]. The default time zone is Pacific Time.

Enable/Disable System Tone

From the home menu, touch  > [General] > [System Tone].



When disabled, sound will not be made when touching a button or option on the screen.

Set Screen Brightness

You can enable night detection and automatic dimming, and adjust screen brightness for day and night settings.

Refer to "Display Settings" section. (P.24)

Set Sound Effects

From the home menu, touch  to access predefined sound modes or customize equalizer settings. Or touch  > [Audio] > [EQ].

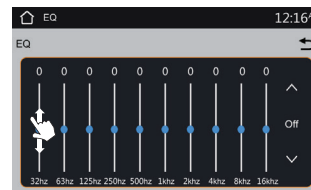

To select a preset sound mode (Jazz, HipHop, Pop, Rock or R&B), touch \wedge or \vee .

To customize equalizer setting, touch \wedge or \vee until [User] appears then swipe up or down each frequency bar to adjust decibel output.

FM/AM Radio

Using FM/AM

Radio Home Screen

From the home menu, touch the tuner icon to switch to radio.

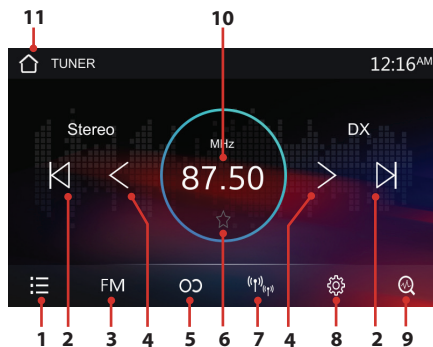

- 1 Access the stored stations and favorite stations.
- 2 Tune to a station, or select a stored station.
- 3 Switch between FM and AM.
- 4 Adjust radio frequency in steps.
- 5 Switch between Stereo and Mono reception (only applicable to FM).
- 6 Set/remove the current station as favorite.
- 7 Switch between local and distant station reception (only applicable to FM).

- 8 Access radio settings menu (e.g. RDS/RBDS options). (P.26)
- 9 Search and store FM or AM stations.
- 10 Touch the radio frequency to access the favorite stations.
- 11 Return to the home menu.

Tune to a Radio Station

Touch and hold or . The unit automatically tunes to a station with strong reception.

To fine tune a station

Touch repeatedly or to change frequencies in steps.

Auto Store Radio Stations

Touch to perform radio search. All available stations in FM or AM band are stored on the unit.

Select a Stored Station

Touch briefly or to select a stored station. Or touch to access the station list for stored FM and AM stations.

Set a Favorite Station

When listening to a station, touch to set the current station as favorite. The gray star icon will turn to the red star icon.

To remove the favorite, touch .

To access the set favorite stations, touch .

FM Local and Distant

Touch to select local or distant station reception. "LOC" display indicates local reception, "DX" display for distant reception.

Select "DX" when most FM stations are weak (e.g. in the countryside). Stations with both strong and weak signals will be received.

Select "LOC" when most FM stations are strong enough (e.g. in urban areas). Only the stations with strong signal will be received.

FM Stereo and Mono

Touch to select Stereo or Mono reception.

When FM signal is weak, select Mono to improve sound quality (stereo will be lost).

Apple CarPlay

Using CarPlay

Apple CarPlay Introduction

CarPlay provides a smarter, safer way to use your iPhone while driving. The apps on your iPhone can be loaded and displayed on the screen of this unit. Thus, you can navigate, call, control you music and so more with hands-free control on your mobile phone.

For more details about Apple CarPlay, visit <http://www.apple.com/ios/carplay>.

Compatible iPhones

CarPlay works with iPhone 5 and all the way up to the most recent versions.

IMPORTANT NOTE

When CarPlay is enabled, hands-free calls and streaming through Bluetooth is not available through Bluetooth.

You can make hands-free calls and streaming through the CarPlay app.

Connect your iPhone

USB cable connection will enable CarPlay feature. iPhone pairing is not needed.

1. Connect your iPhone to the "Apple CarPlay" USB port, using an Apple-certified lightning cable with factory length or shorter (not included). (P.31)

The apps from the iPhone will be loaded onto the unit.

Touch the **Apple CarPlay** icon on the unit's home menu to access the loaded apps for navigation, phone and music, etc.



- 1 **Menu bar:** Touch an app icon for quick access.
- 2 **CarPlay home button:** Return to the CarPlay home screen.
- 3 **Unit's home button:** Exit the CarPlay screen and return to the unit's home menu.
- 4 **Apps loaded from the iPhone.**

Use Voice Assistant

Touch  on the unit's front panel to activate voice assistant, then speak your command.

Make sure the supplied external microphone is connected to the unit. (P.31)

Switch to CarPlay from Other Source

Touch once or more  on the unit's front panel.



For your safety, park your vehicle in a safe place and engage the parking brake when you make any setup which requires extended time.

Apple CarPlay

Using CarPlay

Arrange your CarPlay Apps

You can add, remove, or arrange the order of the apps on the CarPlay screen of the unit.

1. On your iPhone, go to **Settings > General > CarPlay**, select this unit's name from the device list (shown below). Then select **Customize** to access CarPlay apps.

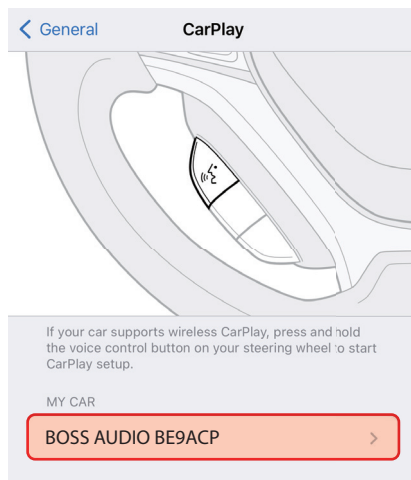

2. Touch and drag an app (☰) to change the order of the app.

Touch **−** or **+** to remove and add apps,

Only apps with **−** or **+** can be removed from CarPlay or added in CarPlay.

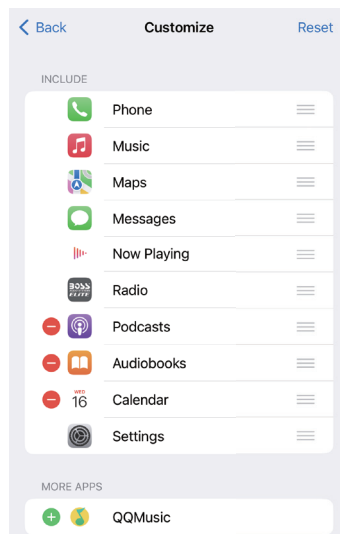

Disable CarPlay Apps

You can disable all CarPlay apps to restrict CarPlay use on this unit.

On your iPhone, go to **Settings > Screen Time > Contents & Privacy Restrictions > Allowed Apps > CarPlay**.

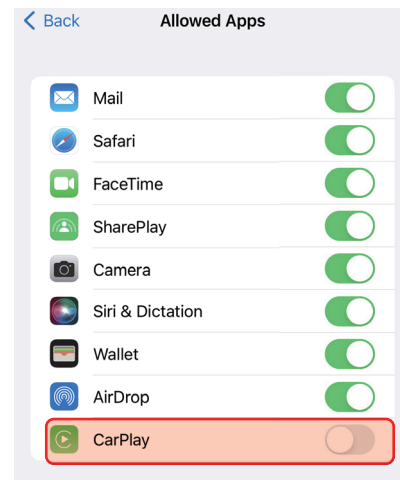

Android Auto

Using Android Auto

Android Auto Introduction

Android Auto allows the apps on your Android phone to be loaded and displayed on the screen of this unit. Thus, you can navigate, call, control your music and so more with hands-free control on your mobile phone.

For more details about Android Auto, visit <http://www.android.com/auto>.

Compatible Android Phones

Android Auto works with phones running Android 6.0 and later.

Android Auto App

- Phones with Android 9.0 and earlier needs Android Auto app downloaded from Google Play Store.
- Phones with Android 10 and above do not need to download Android Auto app.

IMPORTANT NOTE

When Android Auto is enabled, hands-free calls and streaming through Bluetooth is disabled. You can make hands-free calls and streaming through the Android Auto app.

Connect your Android Device

USB cable connection will enable Android Auto feature. Bluetooth pairing is automatically between the unit and your phone.

1. Connect your Android phone to the "Android Auto" USB port, using a certified cable with factory length or shorter (not included). (P.31)

The apps from the Android device will be loaded onto the unit.

Touch the **Android Auto** icon on the unit's home menu to access the loaded apps for navigation, phone and music, etc.

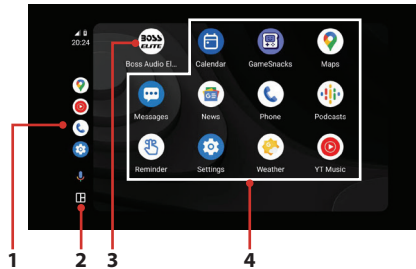

- 1 **Menu bar:** Touch an app icon for quick access.
- 2 **Android Auto Home button:** Return to the Android Auto home screen.
- 3 **Unit's Home button:** Exit the Android Auto screen and return to the unit's home menu.
- 4 **Apps loaded from the Android Phone.**

Use Voice Assistant

Touch  on the unit's front panel to activate voice assistant, then speak your command.

Make sure the supplied external microphone is connected to the unit. (P.31)

Switch to Android Auto from Other Source

Touch once or more  on the unit's front panel.



For your safety, park your vehicle in a safe place and engage the parking brake when you make any setup which requires extended time.

Bluetooth

Connection

IMPORTANT NOTE

Bluetooth on the unit is enabled only when CarPlay or Android Auto is not connected. Make sure your CarPlay or Android Auto is disconnected for Bluetooth use.

Compatibility with all mobile devices is not guaranteed.

First Time Connection

When you connect your Bluetooth device to this unit for the first time, pair the device with this unit.

1. On your mobile device, go to **Settings** > **Bluetooth**, and select this unit's name (**BOSS AUDIO BE9ACP**) to pair.

2. Follow on-screen instructions to complete pairing.

When prompted during pairing, select "Allow" on your mobile phone so that your phonebook and call history can be downloaded and displayed on the screen of this unit.

Bluetooth Reconnection

The unit will automatically connect with the last paired device each time they are powered on.

Connection to a Second Device

You need to disconnect the currently connected device before you can pair or connect a second device.

1. From the home menu, touch  then

select **[Device]** to display the connected/paired devices.

2. Touch the connected device name to disconnect Bluetooth connection.

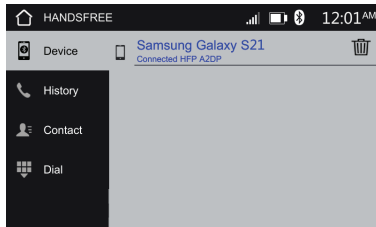

3. You can now pair/connect with a second device.

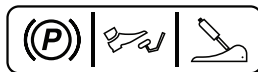

For your safety, park your vehicle in a safe place and engage the parking brake when you make any setup which requires extended time.

Streaming

Audio Streaming

Before you can stream audio from your mobile device to this unit, make sure Bluetooth connection is made.

1. From the home menu, touch 

The music from the device plays automatically.

Playback Control

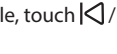
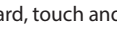
- To play or pause, touch .
- To skip to the previous or next file, touch .
- To search fast backward or forward, touch and hold .

IMPORTANT NOTE

For best performance, your mobile device volume should be set to maximum.

All volume adjustment should be controlled from the unit.

Bluetooth

Handsfree Call

Make a Call

From the home menu, touch



The calling interface is displayed.

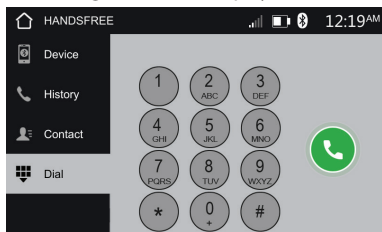

3 Options to Dial a Bluetooth Call

- Input a phone number on the virtual keypad, and touch .
- Touch **[Contact]** tab to access your contact list, then touch a contact.
- Touch **[History]** tab to access your call history, then touch a number.

Operation During a Call

- To end a call, touch .
- To mute a call, touch .

- To use a keypad during a call, touch .
- To switch to private mode, touch . The call will move to your mobile device.
- To return to hands-free mode, touch . The call will move back to the unit.

Sync Phonebook and History

Touch **[Contact]** or **[History]** tab, then **[Download]**.

The phonebook and call history from your mobile phone will be displayed on the unit.

Search a Contact

Touch **[Contact]** tab, then . The alphanumeric keypad is displayed. Enter a contact name for search.

Browse Call History

Touch **[History]** tab to display the call history.

- Outgoing call
- Incoming call
- Missed call

Voice Assistant (Push-To-Talk)

View Connection Status

Touch **[Device]** tab to display the paired devices.

- A highlighted device name indicates the currently connected device.
- To connect a paired device, simply touch the paired device name.
- To delete a paired device from the memory, touch .

Voice Assistant (Push-To-Talk)

You can access smartphone voice assistant through the unit.

Before you Start

- Enable Bluetooth connection between your smartphone and the unit, or enable Apple CarPlay/Android Auto.
- Make sure the hands-free microphone is connected to the Microphone Input of the unit for audio input. *(P.31)*

Touch on the unit's front panel to activate voice assistant, then speak your command.

USB

USB Playback

You can play audio, video and photos stored on a USB flash drive. Connect your USB flash drive to the rear USB port labeled "USB/Charging".

From the home menu, touch



Music from the device plays automatically.

If there are audio, video and photo files in the USB, audio files will play first.

Audio/Video/Photo Play Switching

1. In the playback interface, touch . The file browser bar is displayed.



2. Touch [Music], [Video], or [Image] tab to select an audio, video or picture file to play.

IMPORTANT NOTE

Video and photo cannot not be viewed while driving. The vehicle must be stationary and the parking brake applied to enable viewing.

To activate viewing, also make sure the parking brake wire on the unit is properly connected to your vehicle. (P.29)

Audio Playback

In the audio playback interface, playback control is displayed.

- To play or pause, touch or .
- To skip to the previous or next file, touch .
- To search fast backward or forward, touch and hold until a speed number appears then touch repeatedly to select a search speed.
- To select a repeat mode, touch .
- To turn on or off shuffle play, touch .

Video Playback

In the video playback interface, touch the screen to display playback control.

- To play or pause, touch or .
- To skip to the previous or next file, touch .
- To search fast backward or forward, touch and hold until a speed number appears then touch repeatedly to select a search speed.
- To select a repeat mode, touch .

Video Settings

During video playback, touch to access the Brightness / Contrast / Color settings.

Photo Playback

In the photo playback interface, touch the screen to display playback control.

- To play or pause, touch or .
- To select the previous or next file, touch .
- To select a repeat mode, touch .
- To enlarge the picture, touch then drag the magnifying slider.
- To rotate the picture, touch .



Watching video or photo while driving is against Federal, State, and Local laws.

Do not use features of this unit if it cannot be operated safely and legally in your location.

Other External Devices

Audio/Video Input

Camera

Playback

From the home menu, touch .

Audio and video input screen is displayed.

Audio Input

You can listen to an audio device (e.g. a mobile phone or MP3 player) through this unit.

Audio Cable Connection

Connect the RCA inputs ("L-IN" and "R-IN") on the unit's back to the audio output on your device. (P.30)

If your device does not have an RCA, use the following audio cable (not included).

- For a device with 3.5mm headphone jack, use a 3.5mm to RCA audio cable.
- For a device with USB-C port, use a USB-C to RCA audio cable.
- For an iPhone, use a lightning to RCA audio cable.

Video Input

You can play video from a playback device (e.g. a CD/DVD, ect.).

AV Cable Connection

Using audio/video cables (not included), connect the RCA inputs ("L-IN", "R-IN" and "V-IN") on the unit's back to the RCA outputs (yellow/white/red) on your playback device. (P.30)

IMPORTANT NOTE

Use the controls on the external device for playback control.

Video cannot be viewed while driving. The vehicle must be stationary and the parking brake applied to enable viewing.

WARNING

Never rely solely on the backup camera; always check your surroundings before backing up.

Images may appear reversed if your camera is not properly installed or set up.

Do not use features of this unit if it cannot be operated safely and legally in your location.

Make sure front/rear camera connection is correctly made. (P.31)

Manual Camera Trigger

From the home menu, touch  to access front and rear camera view options.

Note: To make available the camera view options, enable the camera signal and power input. From the home menu, touch  > [Camera].

On the camera view screen, touch the camera icon to switch between front and rear camera view.

Automatic Camera Trigger

When the vehicle is put into reverse gear, the rear camera view will turn on automatically. The front camera view is not accessible when reversing.

IMPORTANT NOTE

For automatic rear camera trigger, make sure the purple/white wire (labeled "REVERSE INPUT") from the supplied wire harness is connected to the reverse light. (P.27)

System Settings

General Settings

From the home menu, touch  > [General] to access general settings.

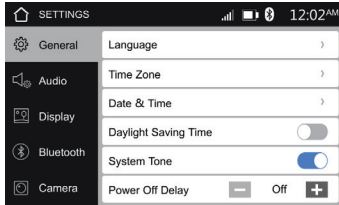



Language Setting

[**Language**]: Select English or Spanish as display language for menu.

Set Date and Time

[**Time Zone**]: Select a time zone in your current location.

[**Date & Time**]: Access to set the following date and time options. Touch  or  to change settings.

- Select 12 or 24 hour format
- Set month, day and year
- Set hours, minutes and AM/PM

[**Daylight Saving Time**]: Enable to adjust Daylight Saving automatically.

System Tone and Shutdown Delay

[**System Tone**]: Enable or disable touch sound.

[**Power Off Delay**]: Enable to keep the unit on for a set time (0/1/2/3 seconds) after accessory power or vehicle is turned off.

Enable shutdown delay if the unit restarts during vehicle's crank to start.

Resetting the Unit

[**Factory Reset**]: Reset the unit to the factory settings.



Reset the unit only when the unit fails to function normally. All your settings will be erased after resetting.

Startup Message Display

[**E.U.L.A.**]: Turn on or off display of the EULA (End User License Agreement) about driving safety notice when the unit is powered on from vehicle ignition.

Audio Settings

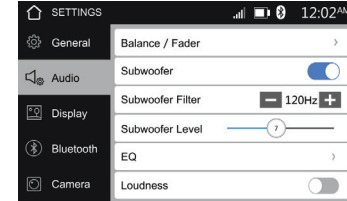

From the home menu, touch  > [Audio] to access audio settings.



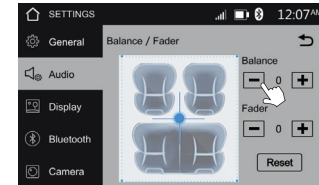

Volume Balance Setting

[**Balance / Fader**]: Adjust volume balance between the front or rear speakers.



Touch  or  from [**Balance**] to adjust right and left volume balance until you are pleased with the sound and a suitable balance is found.

Touch  or  from [**Fader**] to adjust front and rear volume balance until the sound has a satisfying depth.

System Settings

Audio Settings

Subwoofer Setting

[**Subwoofer**]: Enable or disable subwoofer output.

[**Subwoofer Filter**]: Adjust the cutoff frequency for the subwoofer. Only the frequencies below the one you set will be received to reproduce sound.

[**Subwoofer Level**]: Adjust volume output for subwoofer.

Loudness and Sound Mode Setting

[**Loudness**]: Enable to boost output of low and high frequencies.

[**EQ**]: Select a predefined sound mode or customize equalizer settings. (P.13)

Internal Amplifier On/Off

[**Internal Amp**]: When using the pre-amp audio outputs, turn off the internal amplifier to reduce the possibility of noise entering the signal chain.

Startup Volume Setting

[**Main**] (under [**Default Volume**]): Set a desired volume for main audio (radio and media play) when the unit starts up with main audio.

1. Adjust the slider to set a new volume value.
2. Startup volume will be the set volume if the set volume is less than the last shutdown volume (as main audio).
Startup volume will be the last shutdown volume if the set volume is greater than the last shutdown volume (as main audio).

Initial Volume Setting for Other Sources

You can set desired initial volumes for the following sources (under [**Default Volume**]).

- [**BT Ring**]: Bluetooth ringtone volume.
 - [**BT Talking**]: Bluetooth call volume.
 - [**Navi**]: Navigation volume.
 - [**Voice**]: Voice assistant volume.
1. Adjust the respective slider to set a new volume value.
 2. Initial volume will be the set volume if the set volume is less than the last used volume.
Initial volume will be the last used volume if the set volume is greater than the last used volume.

Customization of a Source Volume

You can increase or decrease one of the following source volumes, without affecting volume of other sources (under [**Source Level**]).

- [**Radio**]: Adjust radio volume alone.
- [**USB**]: Adjust USB playback volume alone.
- [**BT Audio**]: Adjust Bluetooth streaming volume alone.
- [**AV Input**]: Adjust audio input volume alone.
- [**Apple CarPlay**]: Adjust CarPlay volume alone.
- [**Android Auto**]: Adjust Android Auto volume alone.

System Settings

Display Settings

From the home menu, touch  > [Display] to access display settings.

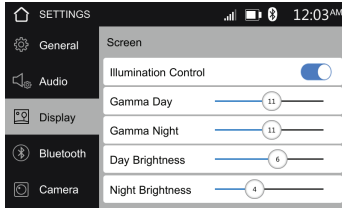

Automatic Dimming Control

[**Illumination Control**]: When enabled and the vehicle light is turned on, the screen brightness and panel button lights will automatically dim.

IMPORTANT NOTE

To enable night detection and auto dimming, make sure the illumination input wire (Orange) from the supplied wire harness is connected to your vehicle's parking light. (P.27)

Bluetooth Settings

Make sure CarPlay or Android Auto is not connected to enable unit's Bluetooth.

From the home menu, touch  > [**Bluetooth**] to access Bluetooth settings.

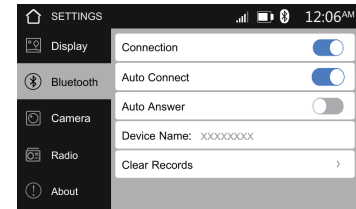

[**Connection**]: Enable or disable Bluetooth function.

[**Auto Connect**]: Enable to automatically connect the paired Bluetooth device.

[**Auto Answer**]: Enable to automatically answer an incoming call.

[**Device Name**]: Show the unit's Bluetooth name.

[**Clear Records**]: Clear all the paired Bluetooth devices from the unit's memory.

Screen Setting

[**Gamma Day**]: Change the differences between dark and light area. Applicable when your vehicle light is turned off.

[**Gamma Night**]: Change the differences between dark and light area. Applicable when your vehicle light is turned on.

[**Day Brightness**]: Adjust screen brightness. Applicable when your vehicle light is turned off.

[**Night Brightness**]: Adjust screen brightness. Applicable when your vehicle light is turned on.

Panel Button Light Setting

[**Panel-Light**]: Select one of six colors for panel button lights. Make sure [**LED Animation**] option is disabled to make the feature active.

[**LED Animation**]: Enable to automatically cycle the panel button lights through six different colors.

Wallpaper Setting

[**Wallpaper**]: Change a wallpaper for home, radio, or media playback screen.

[**Background Brightness**]: Increase or decrease brightness of the wallpaper.

System Settings

Camera Settings

From the home menu, touch  > [Camera] to access camera settings.

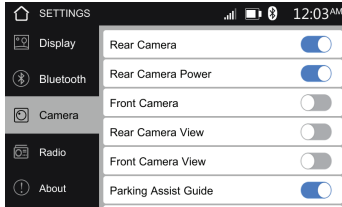

Camera Trigger Control

[Rear Camera]: Enable or disable rear camera signal input.

[Rear Camera Power]: Enable or disable rear camera power output. The option is invisible when [Rear Camera] is turned off.

[Front Camera]: Enable or disable front camera signal input.

[Front Camera Power]: Enable or disable front camera power output. The option is invisible when [Front Camera] is turned off.

[Rear Camera View]: Enable or disable rear camera view.

[Front Camera View]: Enable or disable front camera view.

[Rear View Delay]: Delay trigger of rear camera view by a set time (0/0.1/0.5/1/2 seconds). A proper time setting prevents the unit's screen from blinking when shifting gears.

IMPORTANT NOTE

For automatic rear camera trigger, ensure the purple/white wire (labeled "REVERSE INPUT") from the supplied wire harness is connected to the reverse light. (P.27)

Parking Assist Guidelines Setting

[Parking Assist Guide]: Disable the parking assist guidelines built in the unit if your rear camera view has its own parking assist guides.

[Parking Assist Guide Adjust]: Adjust the parking assist guidelines built in the unit.



Touch and drag a square icon to reposition the related guideline. Repeatedly touch an arrow icon to fine tune positioning of the related guideline. Touch [OK] to confirm the adjustment.

To reset to the default positioning of the guideline, touch [Reset].

System Settings

Radio Settings

From the home menu, touch  > [Radio] to access radio settings.

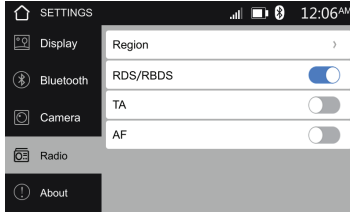

Radio Region Selecting

Select a radio region where your unit is in.

[Europe]: Enable if you are in this area.
Tuner spacing: FM (50 kHz), AM (9 kHz)

[USA 1]: Enable if you are in this area.
Tuner spacing: FM (100 kHz), AM (10 kHz)

[USA 2]: Enable if you are in this area.
Tuner spacing: FM (200 kHz), AM (10 kHz)

RDS/RBDS Activation

[RDS/RBDS]: Enable or disable RDS/RBDS function.

When enabled, it also allows FM stations to display additional information (i.e. station name, program type or other dynamic/static message).



IMPORTANT NOTE

Not all FM stations will have or display RDS/RBDS information.

RDS/RBDS Traffic Announcement

[TA]: When enabled, the unit will automatically tune in to traffic information broadcast despite the media source you are currently in.

Once the traffic announcement ends, the original source will automatically resume.

RDS/RBDS Alternative Frequency

[AF]: When enabled, the unit will automatically locate the same tuning program on other stations and select the strongest signal of those being broadcast.

This feature is most useful on long trips when your car goes out of the range of a radio station.

System Information/SWC Retention

From the home menu, touch  > [About] to access system information.

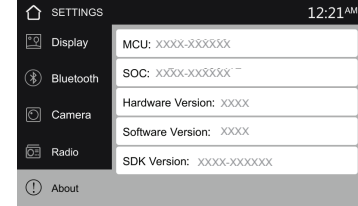

Firmware Version Information

Version information starts with **MCU**, **SOC**, **Hardware Version**, **Software Version**, or **SDK Version**.

Steering Wheel Control Retention

The unit allows you to retain your steering wheel controls through connection to a third-party SWC adapter (not included). (P.27)

Follow the instructions of your SWC adapter to program the unit's audio and video functions on your steering wheel controls.

Not all OEM steering wheel controls may be supported.

Connections

Power and Steering Wheel Control (SWC) Wiring

⚠ WARNING

See the section "Installation Warnings". (P.5)

i IMPORTANT NOTE

Unused input/output wires need to be insulated with tape, heat shrink, or crimp connectors.

Never use wire nuts.

Always replace the faulty fuse with the same type and rating (15A).

Illumination input wire (Orange) must be connected to the parking light for night detection and auto dimming in screen and panel button lights.

Reverse Input wire (Purple/white) must be connected to the reverse light wire for automatic rear camera trigger when the gear is changed to reverse.

* Power output is max. 500mA, 12V. It is recommended to use a relay if additional power is required.

** Consult a professional installer for a correct SWC adapter for your specific vehicle.

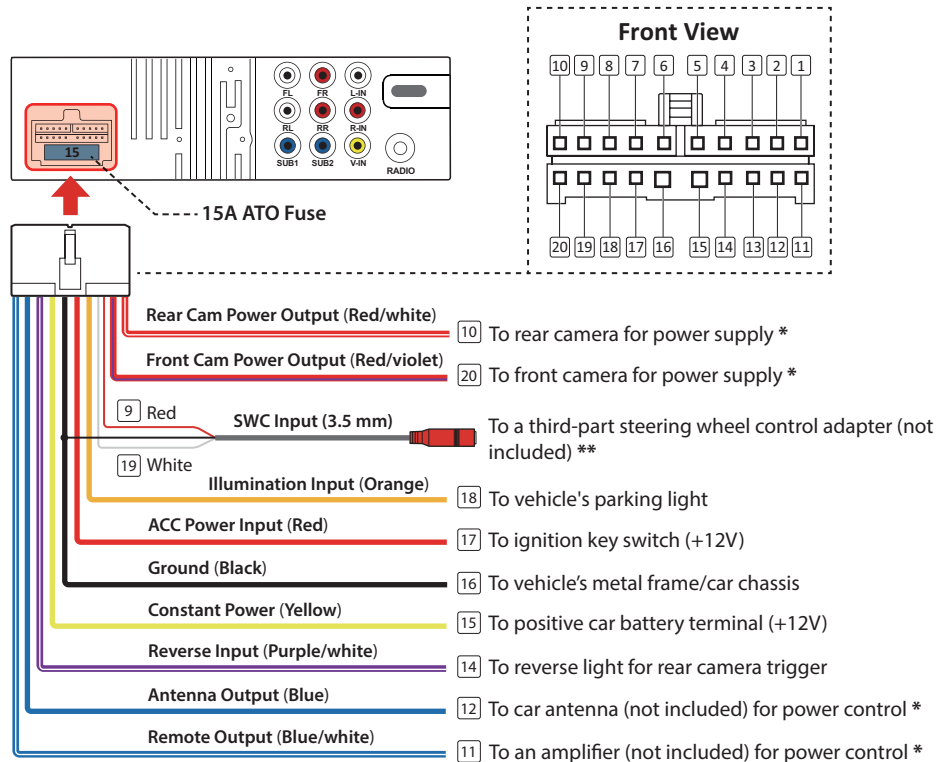

Connections

Speaker Wiring

CAUTION

Do not chassis ground any speaker wire leads.
Only use 4-8 Ω speakers.
DO NOT use 1-3 Ω speakers.
Do not bridge any of the channels. They are only to be wired in stereo mode.

IMPORTANT NOTE

Unused speaker wires need to be insulated with tape, heat shrink, or crimp connectors to avoid damage to the unit. **Never use wire nuts.**
Double check speaker polarity when making connections.

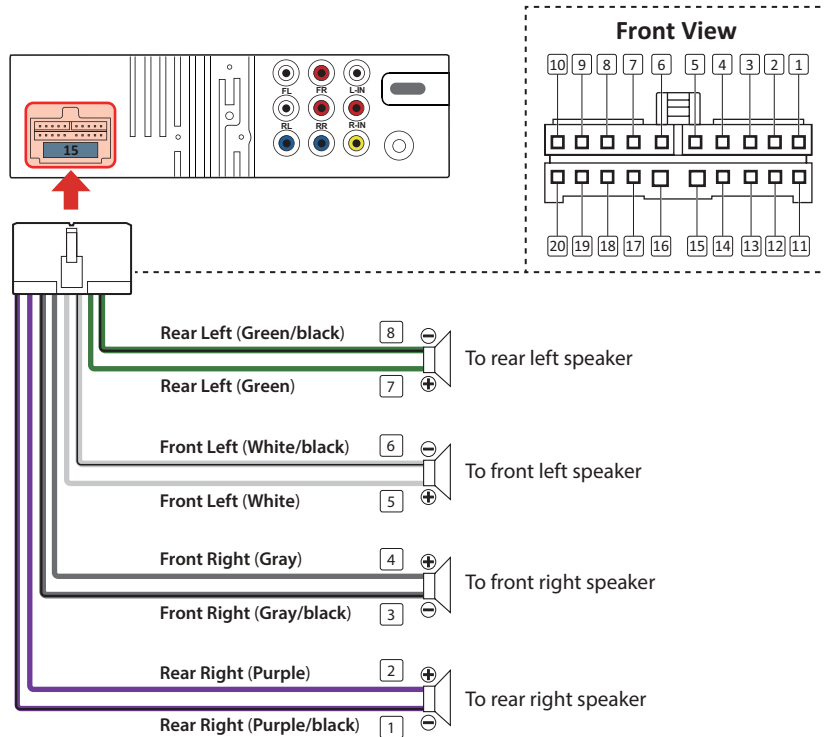

Connections

Parking Brake Wiring

IMPORTANT NOTE

Video and photo playback can be enabled only when the parking brake input wire is connected to your vehicle, and the vehicle's parking brake is engaged.



Park your vehicle in a safe place and engage the parking brake to view video and photo.

WARNING

Improper connection or use of the parking brake status wire (e.g. defeating the safety feature) violates Federal, State, and Local laws. This may lead to injury, property damage, and/or death.

Watching videos or photos while driving is against Federal, State, and Local laws.

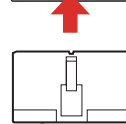
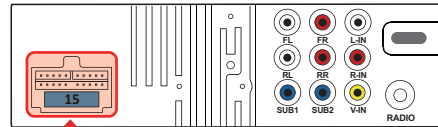

Parking Brake Input (Light green)

13 To vehicle's parking brake switch

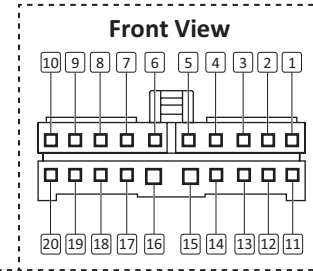

Note

Parking brake wire location varies from vehicles. Consult a professional installer.

Connections

AV/Radio

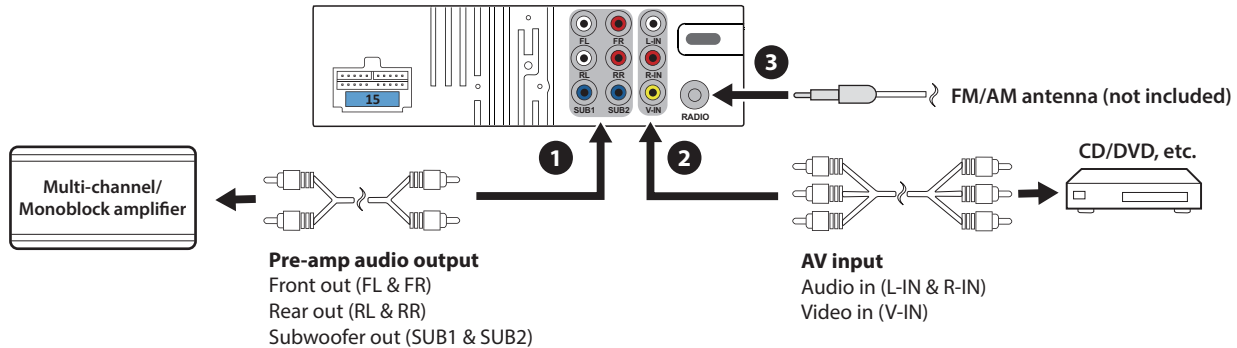

IMPORTANT NOTE

Subwoofer pre-amp is a non-fading mono output.

Always run signal wires away from power cables to reduce the possibility of noise.

- 1** Using RCA audio cables (not included), connect the audio output on the unit to an external amplifier (not included).
- 2** Using RCA audio cables (not included), connect the audio input ("L-IN" and "R-IN") on the unit to a CD player.
Or using an RCA to 3.5mm/USB-C/lightning adapter (not included), connect the audio input ("L-IN" and "R-IN") to the audio output on your mobile phone.
Using a yellow RCA cable (not included), connect the video input ("V-IN") on the unit to the video output on a DVD or other video playback player.
- 3** Connect an FM/AM antenna (not included) for better radio reception.

Connections

Mic/Camera/CarPlay/Android Auto

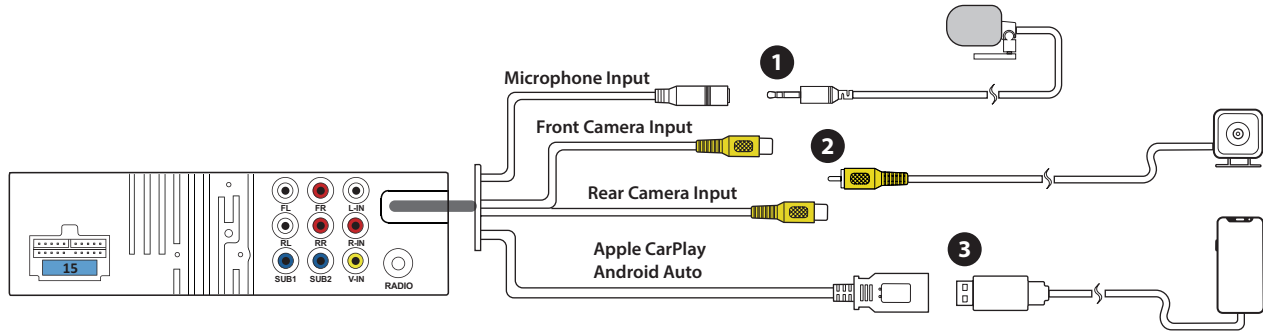

- 1 Connect the 3.5mm plug of the supplied hands-free microphone for sound input when using phone call or voice assistance through Bluetooth or CarPlay/Android Auto.
- 2 Connect the RCA plug of your camera for video signal input.
To operate your rear camera, you also need to connect camera power and reverse signal. (P.27)

- 3 Connect the lightning cable or USB cable of your iPhone or Android device to enable use of CarPlay or Android Auto.
You may also connect a USB flash drive for media playback.



Never rely solely on the backup camera. Always check your surroundings before backing up. Images may appear reversed if your camera is not properly installed or set up. Do not use features of this unit if it cannot be operated safely and legally in your location.

Connections

Hands-Free Mic Installation

Placement

The unit comes with a hands-free microphone with sticky base and 10ft wire.

The location of the microphone can vary from different vehicles due to layout, interior materials, etc.

The **Red** shaded areas are the recommended locations for best microphone performance.

Items to look for before placement:

- Do not place in front of air vents.
- If the vehicle has tweeters placed on sail panel, do **NOT** locate the microphone on steering column area.
- The front of the microphone must not be blocked.
- Microphone should be firmly attached to mounting location.
- Do not cover the grille openings surrounding the microphone.
- To avoid excessive wind noise, do not place near the sunroof opening.

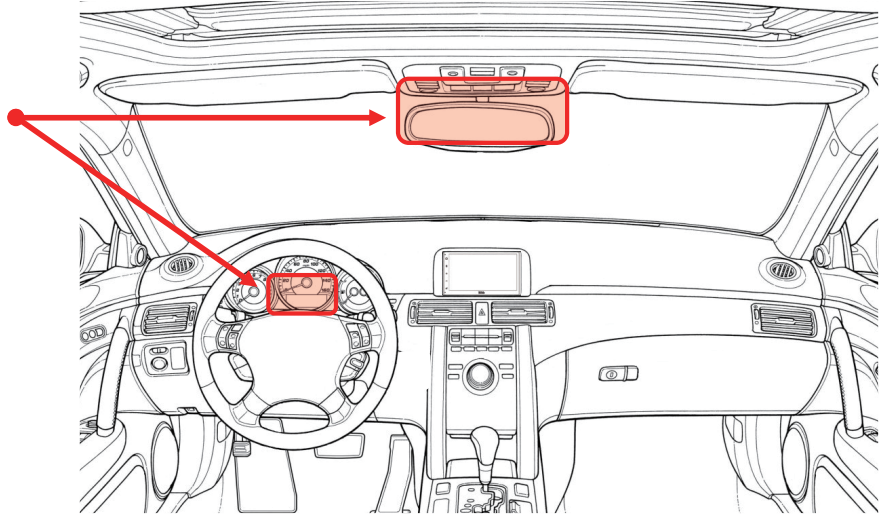

Attach the Microphone

1. Clean the mounting surface.
2. Remove the backing paper from the microphone base, then stick the base onto the mounting surface.
3. Route and secure the microphone wire properly.



WARNING

Run the microphone wire where it will **NOT** impede with the operation of any safety items (e.g. airbags, knee airbags, etc.)

Troubleshooting

Important!

If you have checked the points described in the list and the problem persists, turn off the vehicle for ten seconds then turn it back on again. If the problem still persists after restarting the unit, reset the unit by using a small pin to press the reset button on the bottom side of the display. If you still have problems after applying suggestions above, please contact our Customer Service for further assistance.

General

No response / Screen or unit not powered on / Bad or incorrect picture quality.

- Restart the unit by turning off the vehicle for ten seconds, then turning the vehicle back on.

No sound from the unit.

- The unit is muted. Adjust the volume.
- Select the correct audio source on the unit.

USB

Cannot play a media file.

- The file format on the USB flash drive is not supported by the unit. Change media files.
- The file system of the USB flash drive is not supported by the unit. Change the USB drive.

No video playback or picture display.

- Video or picture display is enabled only when the parking brake is engaged, and the parking brake input wire is connected to your vehicle. (P.29)

Apple CarPlay/Android Auto

Cannot start Apple CarPlay/Android Auto

- Bad USB cable. Replace the cable.
- The mobile phone is locked. Unlock it.
- CarPlay/Android Auto is frozen. Unplug the mobile phone, close all apps and plug the phone in again.

Bluetooth

Cannot make Bluetooth streaming.

- Make sure your mobile phone is within Bluetooth range.
- Pair and connect your mobile phone. (P.18)
- CarPlay or Android Auto is being connected. Unplug your mobile phone from the unit to enable Bluetooth connection.

Poor hands-free phone call quality.

- Check signal strength on your mobile phone.

- Check that the microphone is firmly attached and plugged in. Or relocate the microphone for noise reduction. (P.32)

Cannot make Bluetooth connection.

- CarPlay/Android Auto connection disables Bluetooth on the unit. Unplug CarPlay or Android Auto from the unit to enable Bluetooth connection.
- The unit is already connected to a mobile device. Disconnect the current Bluetooth connection before connecting to another Bluetooth device.

FM/AM Radio

Poor radio reception.

- FM/AM antenna is not connected or extended. Connect and secure an FM/AM antenna (not included). (P.30)
- The antenna output wire is not connected. Connect the wire. (P.27)
- Turn off RDS/RBDS, TA and AF. (P.26)

Specifications

General

Input voltage.....	8.5 – 18 VDC 14.4 VDC (Nominal)
Current consumption	Max. 15 A
Fuse	15 A (ATO, blade)
Dimensions (H x W x D).....	1.97" x 7" x 5.63"
Unit weight.....	3.91lbs.
Operational temperature	-4 – 140°F

Display

Screen size.....	9"
Aspect ration.....	16:9
Resolution	1024 x 600
Screen type.....	TFT-LED Active Matrix

Audio

Max power.....	85 W x 4
Speaker impedance.....	4 – 8 Ω
Preset EQ.....	Jazz, HipHop, Pop, Rock, R&B
EQ bands (Adjustable).....	32/63/125/250/500 Hz 1/2/4/8/16 kHz
EQ boost/cut	±6 dB

Pre-amp output.....	2x Front (4V, full range) 2x Rear (4V, full range) 2x Sub (mono, 4V, LPF)
Sub LPF.....	50/80/120/160 Hz
Sub Level	+1 to +14 dB
Audio input.....	2x RCA, 1 Vp-p/75 Ω

Video

Signal system	NTSC/PAL
Video input (RCA).....	1x RCA, 1 Vp-p/75 Ω

Radio

Frequency range.....	87.5 – 108 MHz (FM) 522 – 1710 kHz (AM)
Frequency step (FM).....	100 kHz (USA 1) 200 kHz (USA 2) 50 kHz (Europe)

RDS/RBDS.....	RT data , TA, AF
---------------	------------------

Apple CarPlay

Device support.....	iPhone 5 or later
iOS.....	iOS 7.1 or later

Android Auto

Android	6.0 or later
---------------	--------------

USB

Compatibility.....	USB-A (2.0, High Speed)
USB port (1).....	CarPlay/Android Auto Charging (1.5A)
USB port (2).....	Media/Charging (1.5A)
Supported USB.....	Max. 32GB
File system.....	FAT32
Audio playback.....	MP3, WMA, WAV, FLAC (192kHz/24bit)
Video playback	AVI, MKV, WMV
Picture playback.....	JPG, PNG, BMP

Note: Not all listed media files are guaranteed to play due to different creation methods or file contents.

Bluetooth

Bluetooth version.....	V4.2 + EDR
Transmission range.....	33ft/10m (line of sight)
Bluetooth profiles.....	A2DP, AVRCP, HFP, PBAP

Specifications are subject to change without notice.





BOSS Audio Systems
3451 Lunar Court - Oxnard, CA 93030
www.bosssaudio.com
805-751-4853 Customer Service
Tech Support: www.bosssaudio.com/support



iPhone® is a trademark of Apple Inc., registered in the U.S. and other countries. Apple CarPlay is a trademark of Apple Inc. BOSS Audio Systems is not affiliated with Apple Inc.

The Bluetooth® word mark and logos are registered trademarks owned by Bluetooth SIG, Inc. and any use of such marks by BOSS Audio Systems is under license. Other trademarks and trade names are those of their respective owners.

Android Auto is a trademark of Google LLC.

Use of the Apple CarPlay logo means that this user interface meets Apple performance standards. Apple is not responsible for the operation of this device or its compliance with safety and regulatory standards.