

USER'S MANUAL

BVCP9685A **BLUETOOTH®** | MP3-COMPATIBLE AM/FM RECEIVER
FEATURING 6.75" (171 mm) CAPACITIVE TOUCHSCREEN

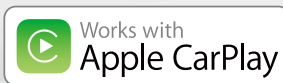



Contents

Contents	2	CarPlay Display.....	16	Media Player Source Switching.....	20
Notes.....	4	Disable Apps.....	16	Media	21
Cautions.....	5-7	Android Auto	17	Warnings.....	21
About this Manual.....	7	Warnings.....	17	USB Playback.....	21
California Prop. 65.....	7	Using Android Auto.....	17	Navigating Menu.....	21
Basic Product Operation	8	Bluetooth®	18	Photos.....	21
What comes in the box.....	8	Cautions.....	18	Radio	22
Product Basics.....	9-14	Setup & Connections.....	18	Display Overview.....	22
Using/Caring for the Touchscreen.....	12	Phonebook.....	18	Controls.....	22
Product Setup.....	13	Device Status.....	18	Tuning.....	22
Navigating the Menus.....	14	Calling.....	19	Bands.....	22
Apple CarPlay	15	History.....	19	Presets.....	22
Warnings.....	15	Private Mode.....	19	Favorites.....	22
Using CarPlay.....	15	Audio.....	20		
Gestures & Control.....	15	Track Control.....	20		

Contents

AV IN	23	Display Settings	26	Connections	28
Playback.....	23	Illumination Control.....	26	Cautions & Warnings.....	28-33
Camera	23	Gamma.....	26	Power/SWC/MIC	28
Warnings.....	23	LED Touch Buttons.....	26	Speaker.....	29
Reverse View.....	23	LED Brightness.....	26	Audio Pre-amp/AV IN/ Radio.....	30
General Settings	24	LED Animation.....	26	Camera/USB.....	31
Cautions.....	24	User Interface.....	26	Parking Brake.....	32
System Language.....	24	Bluetooth® Settings	27	Hands-free Mic.....	33
Time Zone.....	24	Device Name.....	27	Troubleshooting	34
Date & Time.....	24	Camera	27	Specifications	36
Auto Adjust Daylight Saving.....	24	Rear Camera input.....	27		
System Tone.....	24	Rear View pelay.....	27		
Power Off Delay.....	24	Radio Settings	27		
Audio	25	Region.....	27		
EQ.....	25	RBDS.....	27		
Balance/Fader.....	25	Alternative Frequency (AF).....	27		
Subwoofer.....	25	Traffic Announcement (TA).....	27		
Loudness.....	25				
Internal Amp.....	25				
Volume.....	25				
Source level.....	25				

Important

This symbol with “WARNING” is intended to alert the user to the presence of critical instructions/procedures. Failure to observe the instructions/procedures can result in injury, death, damage to the product and/or property.



This symbol with “CAUTION” is intended to alert the user to the presence of important instructions/procedures. Failure to observe the instructions/procedures can result in injury or damage to the product and/or property.



Use of the Apple CarPlay logo means that a vehicle user interface meets Apple performance standards. Apple is not responsible for the operation of this vehicle or its compliance with safety and regulatory standards. Please note that the use of this product with iPhone or iPod may affect wireless performance. iPhone is trademark of Apple Inc., registered in the U.S. and other countries. Apple CarPlay is a trademark of Apple Inc.



The *Bluetooth*® word mark and logos are registered trademarks owned by Bluetooth SIG, Inc. and any use of such marks by Boss Audio Systems is under license. Other trademarks and trade names are those of their respective owners.



IMPORTANT

Record the serial number of the product:

Model:

Serial Number:

Date of Purchase:

The serial number is located on the top part of the chassis.

Caution

Precautions

BE SURE TO OBSERVE THE FOLLOWING GUIDELINES: Do not turn up the volume so high that you can't hear what's around you.

Use caution or temporarily discontinue use in potentially hazardous situations.

Do not operate mobile video equipment while driving a motorized vehicle – safe driving and safety consideration of others should always be your highest priority.

Set your volume control at a low setting, then slowly increase the sound until you can hear it comfortably without distortion, or ear discomfort.

In the event you should notice smoke, strange noises or odor from this product, or any other abnormal signs, immediately turn off the power and consult your dealer or the nearest authorized **BOSS AUDIO SYSTEMS** Service Center.

Using this product in this condition may result in permanent damage to the system.

Installation Precautions

Boss Audio Systems does not recommend to install the product yourself.

We recommend to have it professionally installed by a certified professional.

Always consult with a professional installer .

Do not attempt to install or service this product by yourself. Installation or servicing of this product by persons without professional training and experience in electronic equipment and motorized vehicle accessories may be dangerous and could expose you to the risk of electric shock, injury or other hazards

Refer any repairs to a qualified BOSS AUDIO SYSTEMS Service Center

Caution

Before Installing

To avoid potential shorts in the electrical system, be sure to disconnect the (-) battery cable before installation.

Use this unit with a 12-volt battery and negative grounding only. Failure to do so may result in a fire or malfunction.

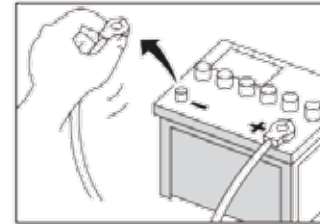
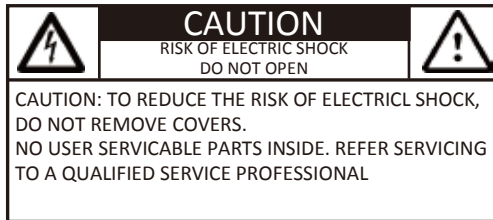

Product Safety

It is against Federal and Local laws for video to be viewed by the driver while the vehicle is in motion. This video product was intended to be used with the parking brake safety feature. Video cannot be seen without the proper parking brake powered connection. Tampering or disabling this feature will void any and all warranty. Please check with a professional installer to have your product installed properly.



Important Note

Due to ongoing enhancements, example images on screens may slightly differ from actual product.

Caution

Images and Video

Watching video while driving is against Federal, State, and Local laws.

Drive safely, know and obey traffic rules. Watching this screen and making selections while driving can lead to a serious accident.

Check surroundings for safety while camera images are displayed.

Do not use features of this product while driving if it cannot be operated safely and legally in your location. Before operation of smartphone Apps accessible from this device, read safety instructions in your Owner's Manual. When using navigation Apps stay alert to observe real world conditions.

About this manual

To entirely understand how to properly use your new Boss product, it is recommended to read this entire user's manual, and keep it in a safe place for future reference.

- Read the entire manual
- Keep the manual
- Follow all instructions
- Clean with a dry cloth only
- Do not use or operate near water
- Do not defeat any safety features

California Residents (Proposition 65)

This product may contain chemicals known to the State of California to cause cancer, birth defects or other reproductive harm.

Basic Product Operation

What comes in the box

Hardware

- Qty 1 BVCP9685A
- Qty 1 Trim Ring
- Qty 1 Mounting Hardware Set
 - M5 x 6mm Bolts (8)
 - Brackets (2)

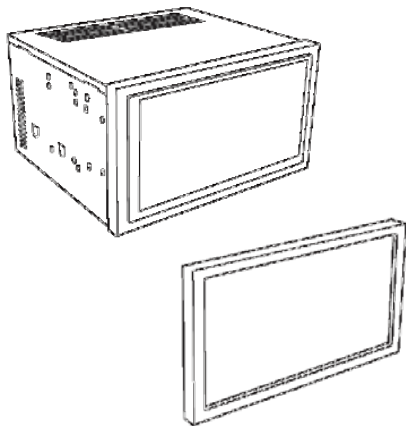

Connections

- Qty 1 Power/Harness
- Qty 1 Hands-free Microphone

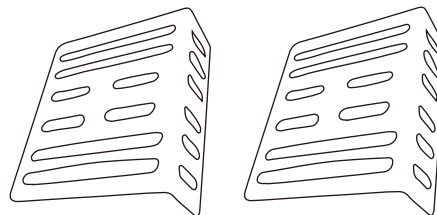
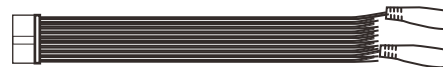
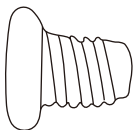
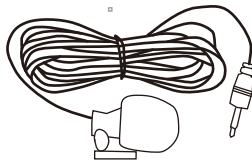

Basic Product Operation

Front Detail

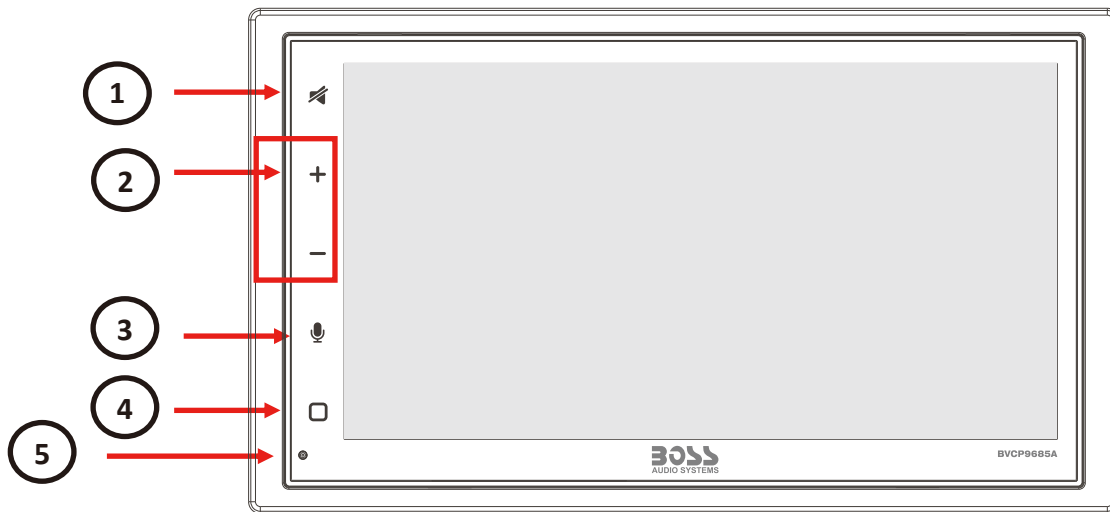

1 Mute/Screen Off

2 Volume Control

3 Siri Button

4 Power/Home

5 System Reset

Basic Product Operation

Rear Detail

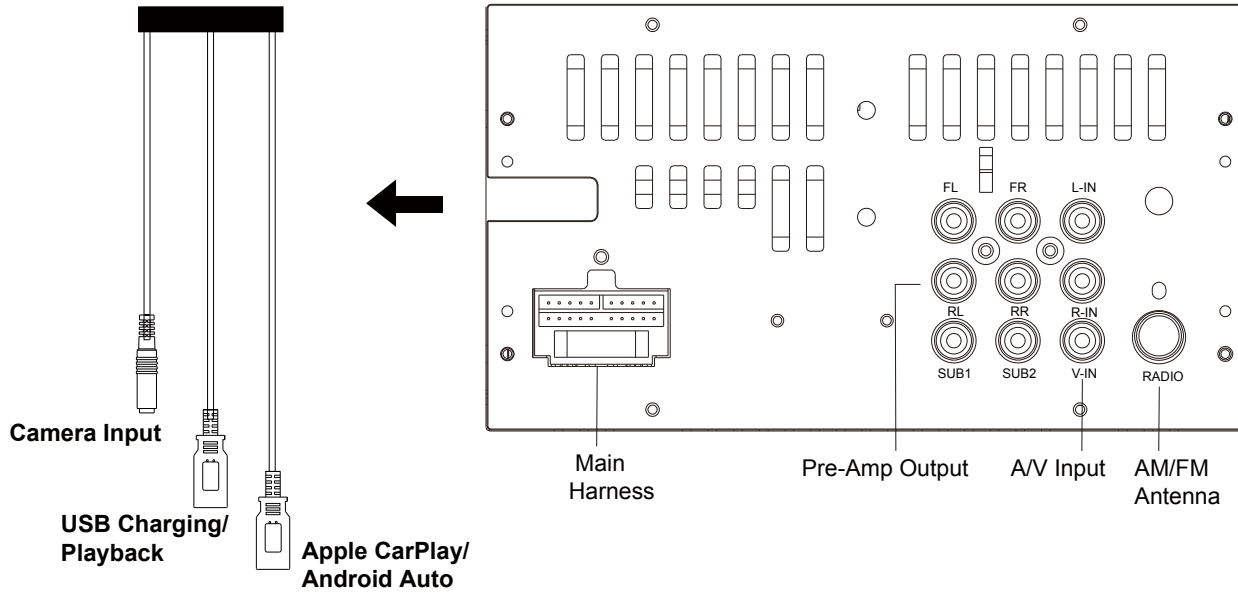

Basic Product Operation

Product Basics

Mute

1. **Touch** to Mute



Volume

1. **Touch** once on either "+" / "-"
2. **Touch and Hold** for quicker operation



Siri

- Touch** to command

NOTE

CarPlay must be active



Display Off

- Touch and Hold** Mute

Display On

- Touch** the display to reactivate



Power On /Standby

1. **Touch** once to Power ON
2. **Touch and Hold** for Standby



NOTE

In **Standby Mode**, the LED will slowly pulse on and off.

Basic Product Operation

Using and Caring for the Touchscreen



Use:

This head unit utilizes a Capacitive Touchscreen, the same type that is used on high-end mobile devices. It should be used for and cared for like that type of device. As with all capacitive type technology, if your fingers are wet or sweaty, it will not function properly.

Do not allow any sharp objects to come in contact with the screen glass.

Care and Cleaning:

To clean the screen, use a dry microfiber type cloth to clean. Do not use ammonia, window cleaner, or any other type of household chemicals to clean the screen. Abrasives should not be used at all.

Basic Product Operation

Product Setup (Date & Time)

Setup Option A: CarPlay Method

Connect your Apple® device using a Lightning® cable*. The CarPlay USB port must be used.

This will automatically setup the time and date.

User must set Time Zone manually.

Default is Pacific Time Zone

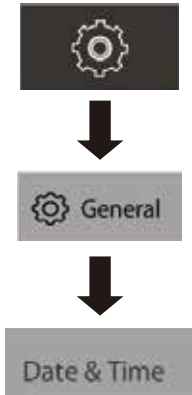

Setup Option B: Date and Time

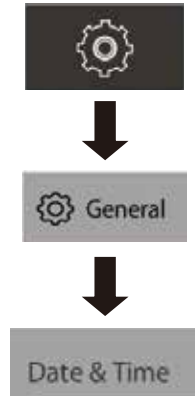

Additional Setup

General > Language

Audio > EQ, Other Audio Settings

Display > Illumination, Brightness, LED

Basic Product Operation

Navigating the Menus

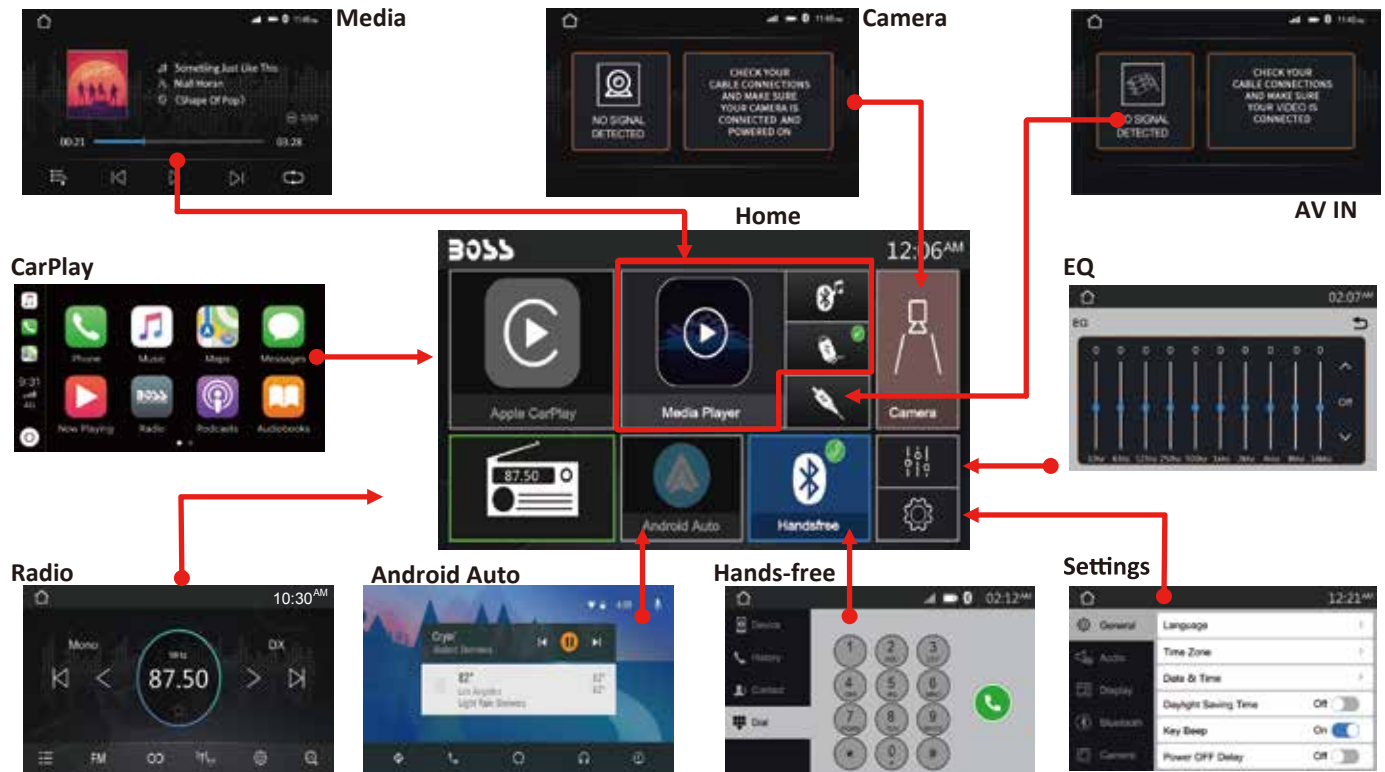

Apple CarPlay

Using CarPlay

Note

Apple CarPlay usage is limited while driving. Functions, contents, and usability is determined by the App provider(s).

Controls will vary with each App that is available for CarPlay.

For more details visit:

<http://www.apple.com/ios/carplay>

WARNING

Familiarize yourself with your Local and State laws regarding mobile devices.

Certain functions of an iPhone might be prohibited and or illegal while driving in your location.

When in doubt, park the vehicle and engage the parking brake first before performing the function(s).

Connecting to CarPlay USB Port

1. Connect the CarPlay compatible device via LIGHTNING® cable (not included).
2. The iPhone will load the CarPlay function.
3. On the display, the CarPlay will illuminate green, touch it to enter the CarPlay menu.
4. To return to the product Home menu,

Touch



NOTE

The product's Bluetooth will turn **OFF** automatically when CarPlay is in use. Hands-free phoning will function through the CarPlay feature.

When using CarPlay, there is no need to pair your iPhone, the USB cable connected through the USB Port (1) will enable this feature.

If other devices are connected via Bluetooth, they will be disconnected for the duration of CarPlay use.

Gestures & Control

Basic controls, but not limited to:

Touch



Swipe



Dragging



Other gestures and controls might differ on each App.

NOTE

Volume control is handled exclusively by the product.

Apple CarPlay

Using CarPlay

CarPlay Display Setup

1. Using your iPhone:

Settings > General > CarPlay

2. **Touch and Hold** each App icon to move.

To remove an App, **Touch** 

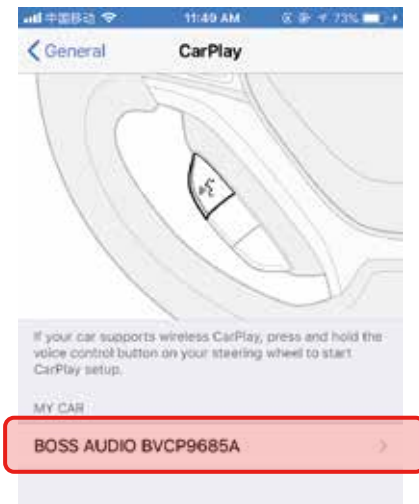

NOTE

Only Apps with the  icon can be removed from CarPlay.



How to Disable Apps

1. Using your iPhone:

Settings > Notifications > *App to Disable*

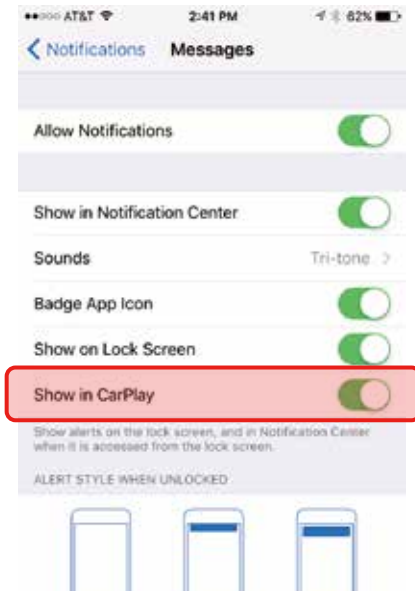

Android Auto

Using Android Auto

Note

Android Auto usage is limited while driving.

Functions, contents, and usability is determined by the App provider(s).

Controls will vary with each App that is available for Android Auto.

For more details visit:

<https://www.android.com/auto/>

WARNING

Familiarize yourself with your Local and State laws regarding mobile devices.

Certain functions of the mobile device might be prohibited and or illegal while driving in your location.

When in doubt, park the vehicle and engage the parking brake first before performing the function(s).

NOTE

To complete the setup properly, the Parking Brake status wire must be connected.

WARNING

For your safety, the setup process **MUST** be accomplished while the vehicle is **Parked and Parking Brake Engaged**.

Android Auto App

1. Using your Android device, download the **Android Auto** app on Google Play.



Minimum Requirements:

Android 5.0 Lollipop

For a list of compatible devices:

<https://www.android.com/auto/>

Updating Related Apps

1. During the first start up and setup of the Android Auto app, the Maps, Music, Google apps will install/update automatically.

Connecting to Android Auto USB Port

1. Connect the Android compatible device via the appropriate USB cable (not included).
2. The Android device will load the Android Auto function.
3. Bluetooth will connect automatically when the setup is completed.
4. To return to the product **Home** menu,

Touch



Android Auto Permissions Permissions

Several features can be allowed or denied access to customize your usability of the product.

The access can always be modified in Settings on the Android device.

Bluetooth®

Setup & Connection

Hands-Free Menu

Touch



NOTE

CarPlay must not be active. If being used, disconnect the iPhone to start Bluetooth.

Compatibility with all mobile devices is not guaranteed. Please read through the user's guide of the mobile device.

CAUTION

For your safety, the setup process should be accomplished while the vehicle is parked and parking brake engaged.

First time Pairing

Using your phone, media or other Bluetooth device, try to connect to this headunit.

Mobile Device:
Search for **BOSS AUDIO BVCP9685A**

iOS Devices: **Settings > Bluetooth**

Android Devices: **Settings > Connections > Bluetooth**

A passcode is generated and will display on both the head unit and mobile device for secure pairing.

Touch  to confirm

Every time the product is powered ON, the mobile device will automatically connect if within range.

NOTE

Once paired and connected, the device list will display the available Bluetooth profiles.



Phonebook and History

To **Download Phonebook:**

1. Touch **Contact > Download**

To **Download History**

1. Touch **History > Download**

Device Status

Battery and Cellular Strength is displayed on the top right of the Home menu.

GATT Profile support is required on the mobile device.



Bluetooth®

Hands-Free

Calling

Making & Receiving Calls

1. Dialing from the dial pad

Touch  to make call

2. Contacts

Touch the contact name

3. History

Choose the name, then

To **End** a call **Touch** 

To **Mute** a call **Touch** 

Dial pad

To use the dial pad while on a call



Touch 

Searching History

Swipe Up or **Down** to search



History

1. Outgoing Call 
2. Incoming Call 
3. Missed Call 

Private Mode

When a call needs to be transferred to the mobile device:

Touch  to switch the mobile device

Touch  to return to hands-free mode

Searching Contacts

Contacts must be downloaded to search.

1. **Touch** 

2. **Enter the Contact Name**, then

Connection: **ON**

Auto Connect: **ON**

Auto Answer: **OFF**

Device Name: **BOSS AUDIO BVCP9685A**

Clear Records

Bluetooth®

Audio

Audio Streaming



To play media through Bluetooth, the mobile device must be **Paired and Connected** to the BVCP9685A

1. Touch



The music will play automatically.

Track Control

1. Play/Pause 
2. Track Fwd / Rev 
3. **Swipe** to Fwd/Rev 

Media Player (Bluetooth)

Playback access is also available through the Media Player

1. Touch



Note

For best performance, your mobile device volume setting should be set to maximum.

All volume adjustments for the system should be controlled from the product.

The unit will recall the last volume setting on your mobile device every time it connects.

Formats

Playback is supported from the mobile device with any format it can play.

Audio will only be played by the product.

Video cannot be viewed on the unit.

Switching Media

Touch



Available sources will display **(Bluetooth and USB)**

Note

USB source will only be displayed if a USB drive is inserted and has playable media.

Display

Track info will be displayed when available.

Track, Album and Artist.

Album art is not supported via Bluetooth playback.

Media

USB

USB Playback

Touch



The music will play automatically.

Audio Control

1. Play/Pause 
2. Track Fwd / Rev 
3. Repeat List 
4. Repeat File 
5. Random 

Note

If there are other files in the USB, music files will play first.

Video Control











1. Play/Pause 
2. Track Forward/Backward 
3. Repeat All 
4. Repeat one 
5. SETUP 

Photo Control

1. Play/Pause 
2. Track Forward/Backward 
3. Repeat All 
4. Repeat One 
5. Rotate 

Navigating Menu

Touch



To browse contents **Swipe**



To return to the current file playing,

Touch 

WARNING

Watching videos or photos while driving is against Federal, State, and Local laws.

Do not use features of this product if it cannot be operated safely and legally in your location.

Note

Review the connections of this product, to properly integrate the parking brake wire to the vehicle.

Video and or photos cannot be viewed while driving. The vehicle must be stationary and the parking brake applied to enable viewing.

Radio

AM/ FM

Controls





Tuning

To search for stations:

Search

Touch and Hold  

Manual Seek

Touch  





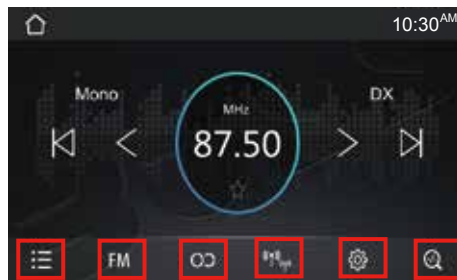

Auto Search & Store: Touch 

Note

RBDS info (if available) and currently tuned station will display on the radio icon in the home screen

Not all stations will have or display RBDS info.



 Station Listings
 Bands
 Stereo/Mono
 LOC/DX
 Settings
 Auto Search & Store

Band & Settings

Touch FM to switch bands

To change radio settings

Touch 

Favorites and Presets

Settings Favorites

Touch  Favorite Set 

To remove a favorite, Touch  **Browsing Favorites**



To return the Tuner screen Touch 

Changing Presets

Touch  

To list all Stored Stations

Touch 

Stereo/Mono

To turn on/off stereo when receiving a stereo signal ,

Touch 

LOC/DX

To select Local or Distant broadcasting stations,

Touch 

AV In/Camera

External Source

Playback

Touch



Media must be controlled from the external device.

Track functions are not controlled from the product.

Note

To adjust the volume level properly, the carry-in device volume should be set between 50 % - 75%. The volume level should remain at that level for the remainder of the time it is connected to the product.

WARNING

Never rely solely on the rear view camera; always check your surroundings before proceeding.

Images may appear reversed

Do not use features of this product if it cannot be operated safely and legally in your location.

Rear View

The rear view camera can be displayed on demand.

Touch



To return to the Home screen

Touch



Reverse View

When the vehicle is put into reverse gear, the camera will display the image on the screen.

CHECK SURROUNDINGS BEFORE PROCEEDING



Rear View Delay

Due to varying vehicle configurations, the rear view trigger can be delayed to best suit the vehicle.

Default setting: **0 Sec** Delay

Note

The rear view camera will still function normally, if the product is in standby mode

Settings

General

System Language

Touch to change

English (Default), Spanish

Note

CarPlay is independent of the system language setting.

Time Zone

Adjust to correctly display time

Default Setting: **(GMT-08:00) Pacific Time (US&Canada)**

Date & Time

24H Mode

Touch 

Auto Adjust Daylight Saving

Touch 

Note

If using an CarPlay, the iPhone will automatically set date & time. Time Zone needs to be adjusted manually.

System Tone

Touch 

Power Off Delay

Some vehicles during crank to start will interrupt the accessory power.

If the product re-boots during crank to start, Turn **ON** delay

The delay can select 1, 2 or 3 sec.

Default Setting: **OFF**

Note

Power Off Delay **ON** will also delay when the vehicle is turned OFF.

This might affect hands-free functionality during a call.

Factory Settings

To restore settings to default:

Touch 



Will restore all settings to factory defaults.

All settings and presets will be lost.

Setting

Audio

EQ

To access the EQ menu

Touch

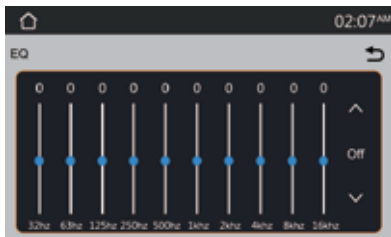

Note

The EQ can also be directly accessed while changing the volume. The volume display will show the EQ icon, you can touch to access the Audio Settings.



Preset EQ

Jazz, HipHop, Pop,Rock, R&B

Balance/Fader

Left/Right Balance, Touch



Swipe for quick adjustment



Front/Rear Fader, Touch



Swipe for quick adjustment



Subwoofer

The level and filter can be adjusted for the Sub pre-amp output.

Level, 1-14 dB

Swipe



Filter: 50Hz, 80 Hz, 120 Hz, 160 Hz

Touch +/- Subwoofer Frequency

Loudness

Enhances and gently boosts low and high freq.

Touch



Internal Amp

To reduce the possibility of noise entering the signal chain when utilizing the audio pre-amp outputs, the internal amp can be turned OFF

Touch



Volume

Settings are for default volumes for Main(Radio, Media), Hands-free(BT Ring, BT Talking), Apple CarPlay/Android Auto (Navi, Voice).

Source Level

The source mode(Radio, USB, BT Audio, AV Input, Apple carplay, Android Auto) gain control.

Settings

Display

Illumination Control



When the vehicle lights are on, the products illumination can be customized for night use.

Gamma

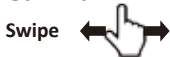

Gamma can be adjusted for both day and night settings.

Screen Brightness



LED Touch Buttons



Six preset colors can be chosen for Touch buttons, or chose below...



LED Brightness



Brightness can be adjusted for both day and night settings.

LED Animation



Will cycle through all colors on LED touch buttons.

Default Setting: ON

UI settings

Wall paper

Touch to change

User can change the background picture by inserting a USB with photos.

Background Brightness



Bluetooth

Connection



Power On/Off Bluetooth

Default Setting: ON



Bluetooth will turn OFF automatically when CarPlay is in use. If other devices are connected via Bluetooth, they will be disconnected for the duration of CarPlay use.

Auto Connect



Auto connects to the device when the product is powered ON

Default Setting: ON

Auto Answer



Auto answers when there is an incoming call.

Default Setting: OFF

Settings

Bluetooth

Device Name

BOSS AUDIO BVCP9685A

Rear Camera input

Turn on if you have a rear view camera, turn off if you have not.

Parking Assist guide

Turn off if your rear view camera have parking assist guide, turn on if you have not.

Parking Assist guide Adjust

You can adjust parking assist guide

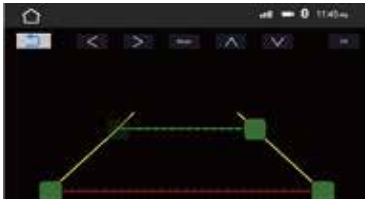

Camera

Rear View Delay

0 Sec (Default), 0.1 Sec, 0.5 Sec, 1 Sec, 2 Sec
When switching from Park to Drive, or vice versa, the camera should not trigger on the display.

Sensitivity should be adjusted to trigger only on reverse gear selector.

Region

Touch 

Default Setting: **USA 2**

US Tuner Spacing: FM (200 KHz), AM (10 KHz)

European Spacing: FM (50 KHz), AM (9 KHz)

RBDS, Radio Broadcast Data System

Touch 

Default Setting: **ON**

Allows data from the radio station to be displayed on the product.

Radio

RBDS, Cont'd

Not all stations will broadcast information to display.

AF (Alternative Frequency)

Touch 

When **On**, the tuner will automatically locate the same tuning program on other stations and select the strongest signal of those being broadcast.

Default Setting: **OFF**

TA (Traffic Announcement)

Touch 

The radio will automatically tune in to traffic information broadcasts while receiving FM broadcasts playing media.

Default Setting: **OFF**

Connections

Power/SWC/MIC

CAUTION

It is recommended to have the product installed by a certified installation professional.

CAUTION

Before installation, or wiring connections, disconnect the negative (-) battery terminal to prevent damage to the product, and/or possible injury.

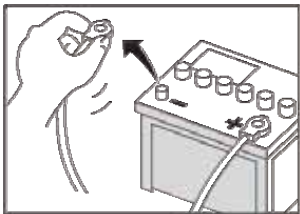

CAUTION

Remote Out is 500 mA max output rating. If several amplifiers are to be used, it is recommended to use a relay for the Remote Out trigger.

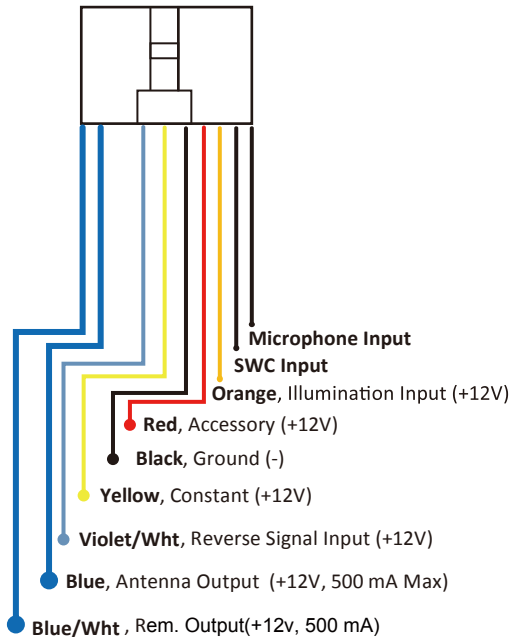

Note

Unused input/output wires need be insulated with tape, heat shrink, or crimp connectors. **Never use wire nuts.**

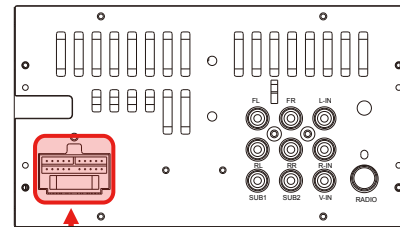

Location to plug in

Note

A separate interface might be needed for your vehicle application. It is recommend that you consult with a professional installer.

Note

When replacing the fuse, always do so with the same type and value (**15 A**).

Connections

Speakers

⚠ CAUTION

Do not chassis ground any speaker wire leads.

⚠ CAUTION

Only use 4-8 Ω Speakers

Do not use 1-3 Ω Speakers

⚠ CAUTION

Do not bridge any of the channels, they are only to be wired in stereo mode.

i Note

Unused speaker wires need be insulated with tape, heat shrink, or crimp connectors.

Never use wire nuts.

If the speaker outputs are not used, turn **Off** the internal amp to reduce the possibility of noise entering the signal chain.

i Note

Observe speaker polarity when making connections.

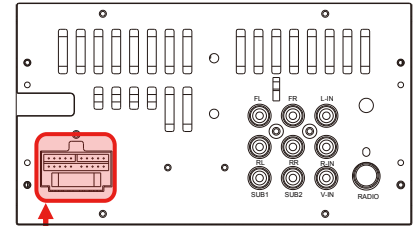
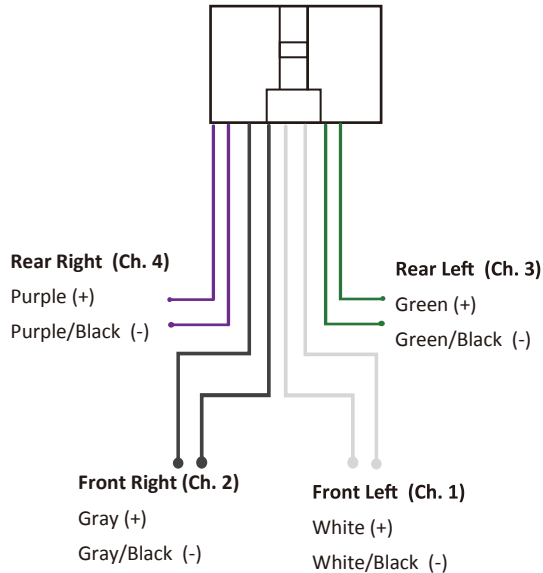

● Location to plug in

Connections

Audio Pre-amp/AV IN/ Radio

i Note

Subwoofer Pre-amp is a non-fading mono output.

i Note

Always run signal wires away from power cables to reduce the possibility of noise.

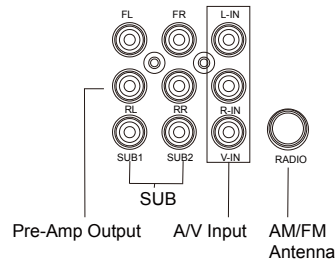

i Note

If pre-amp outputs are being used exclusively, turn **Off** the internal amp of the product, to reduce the possibility of noise entering the signal chain.

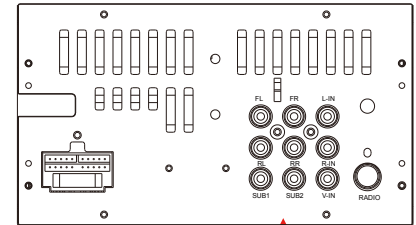

Location to plug in

Connections

Camera / USB

WARNING

Never rely solely on the rear view camera; always check your surroundings before proceeding.

Images may appear reversed

Do not use a feature of this product if it cannot be operated safely and legally in your location.

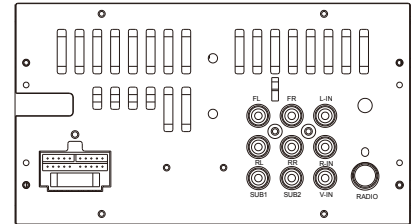
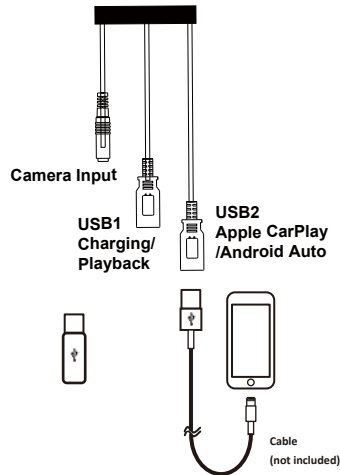

Note

Android device & iOS device playback is not supported from USB port 1.

Connections

Parking Brake

WARNING

Improper connection or use of the parking brake status wire, (i.e. defeating the safety feature) violates Federal, State, and Local laws. This may lead to injury, property damage, and/or death.

WARNING

Watching videos or photos while driving is against Federal, State, and Local laws.

Note

For Android Auto setup, the parking brake status wire **MUST** be connected.

Note

Note

Review the connections of this product, to properly integrate the parking brake wire to the vehicle.

Video and or photos cannot be viewed while driving. The vehicle must be stationary and the parking brake applied to enable viewing.

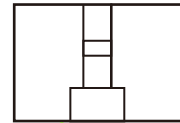

Lt. Green, Parking Brake Input

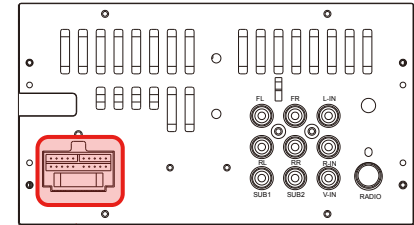

**Power/Speaker/SWC/MIC
Harness**

Note

The parking brake input needs to be connected to the power side of the parking brake.

Note

Every vehicle has a different type of parking brake connection; consult a certified professional installer.

Connections

Hands-free Mic

Placement

Every vehicle will perform differently due to layout, interior materials, etc...

The **Red** shaded areas are the recommended locations for best microphone performance.

Items to look for before placement:

1. Do not place in front of air vents.
2. If the vehicle has tweeters placed on sail panels, do **NOT** locate the mic on steering column area.
3. Front of mic must not be blocked.
4. Mic should be firmly attached to mounting location.
5. Do not cover the grille openings surrounding the mic.
6. To avoid excessive wind noise, do not place near the sunroof opening

WARNING

Run microphone wire where it will **NOT** impede the operation of any safety items, i.e. Airbags, Knee Airbags, etc...

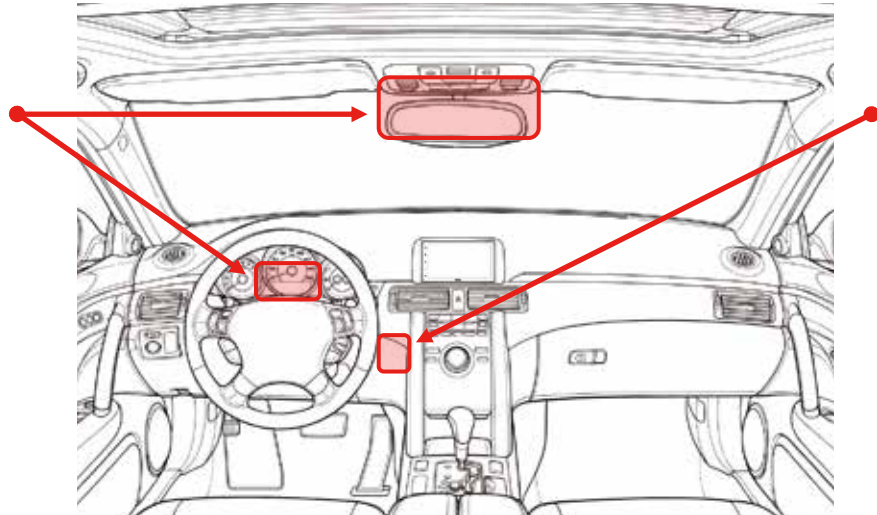

Troubleshooting

Issues	Cause	Solution
No Sound	Internal amplifier is off Product is muted External amplifiers Audio source	Go to Settings > Audio > Internal Amp ON Touch the volume. Check the external amplifiers are on. Check the remote output wire has voltage Change the audio source
Media Not Supported	Media on USB flash drive	Change the media format on the USB device Change the USB device
Bad Radio Reception	Radio area Antenna	Change the station Turn OFF AF and TA Turn OFF RBDS Antenna output wire isn't connected Connect Antenna to product
Apple CarPlay/Android Auto will not start	Bad Lightning®/USB cable Locked device Not charged CarPlay/Android Auto frozen	Replace the cable Device needs to be unlocked Device needs to be powered ON for CarPlay/ Android Auto to function. Allow it to charge and power on. Unplug the device, close all Apps and plug it in again.
Bluetooth	Not connecting to device	Make sure the device is within range. Devices' Bluetooth connection needs to be turned ON

Troubleshooting

Issues	Cause	Solution
Bluetooth	Not connecting to device	Go to Setting >Connection >Power ON Pair and Connect the device like new.
Hands-free call quality	Mobile device Microphone	Check cellular strength on mobile device. End call and redial number. Microphone placement needs to be relocated. Microphone needs to be firmly attached to location it's mounted on. Check to see if microphone is properly plugged in.
Unit is unresponsive	Processor has frozen	Press the RESET button on the front panel



If you have questions about this product:

Customer Service

805-751-4853

M-F 8:30a-5:00p (PST)

Tech Support: www.bossaudio.com/support/technical-support

© 2019 Boss Audio Systems

Specifications

General

Power Input.....	8.5 V—18 V DC
Nominal.....	14.4 V DC
Current Consumption.....	15A
Fuse Type.....	15A
Dimensions (H x W x D).....	3.9" x 7" x 5"
Unit Weight.....	2.43 lbs.
Operational Temperature.....	-4—158°F

Display

Screen Size.....	6.75"
Aspect Ratio.....	16 x 9
Resolution.....	480 x 800
Screen Type.....	TFT-LED Active Matrix

Audio

Max Power.....	80 W x 4 Ch.
Acceptable Speaker Load.....	4-8 Ω
Preset EQ.....	5
EQ Bands, Adjustable.....	10
JAZZ, HIPHOP, POP, ROCK, R&B	
32, 63, 125, 250Hz, 500Hz	
1KHz, 2KHz, 4KHz, 8KHz, 16KHz	
EQ Boost/Cut.....	± 6 dB

Audio Cont'd

Pre-amp Output.....	3 Pairs
Front.....	2V, Full-Range
Rear.....	2V, Full-Range
Sub (Mono).....	2V, LPF
Sub LPF.....	50 Hz, 80 Hz, 120 Hz, 160 Hz
Sub Level.....	+1-14dB

Radio Tuner

Freq. Range.....	87.5 MHz-108 MHz (FM)
Freq. Range.....	522 kHz-1710 kHz (AM)
USA 1 Range (FM).....	100 kHz Spacing
USA 2 Range (FM).....	200 kHz Spacing
Europe Range (FM).....	50 kHz Spacing
RBDS.....	AF, TA

Apple CarPlay

iPhone Support.....	iPhone 5 or Newer
iOS.....	iOS 7.1 or Newer

Android Auto

Supported.....	(5.0) Lollipop or Newer
----------------	-------------------------

USB

USB Spec.....	USB 2.0 (High-Speed)
USB Current Output.....	1.5 A (Max)
File System.....	FAT32
Audio Playback.....	WAV, MP3
Video Playback.....	AVI, MKV, WMV
Picture Playback.....	JPG, PNG, BMP

*Not all listed compressed files guaranteed to play due to different creation methods or file contents.

Bluetooth®

Version.....	v2.1+E.D.R.
Audio Codec.....	S.B.C.
Profiles.....	
A2DP v1.2, AVRCP v1.4, HFP v1.5, PBAP v1.0	

User's Notes

USER'S MANUAL

BVCP9685A

BLUETOOTH® | MP3-COMPATIBLE AM/FM RECEIVER



BOSS Audio Systems
3451 Lunar Court • Oxnard, CA 93030

www.bossaudio.com

800-999-1236 US Toll-free

805-751-4853 Customer Service

Tech Support: www.bossaudio.com/support/technical-support



1218

iPhone® is a trademark of Apple Inc., registered in the U.S. and other countries. Apple CarPlay is a trademark of Apple Inc. BOSS Audio Systems is not affiliated with Apple Inc.

The Bluetooth® word mark and logos are registered trademarks owned by Bluetooth SIG, Inc. and any use of such marks by BOSS Audio Systems is under license.

Other trademarks and trade names are those of their respective owners.

Use of the Apple CarPlay logo means that a vehicle user interface meets Apple performance standards. Apple is not responsible for the operation of this vehicle or its compliance with safety and regulatory standards. Please note that the use of this product with iPhone may affect wireless performance.



LIMITED WARRANTY

This product has a manufacturer's warranty against defects in materials and workmanship to the original purchaser for a period of one year from the date-of-purchase (DOP). This manufacturer warranty is non-transferable. The warranty is for repair or replacement at the sole discretion of BOSS AUDIO SYSTEMS (BAS). For service under this warranty you need to return the product to BAS. If replaced, BAS reserves the right to replace it with a new or reconditioned product of the same or similar design.

Your product may qualify for a free extended warranty. Please see www.bosssaudio.com for the qualifications and details of this program.

Obtain Warranty Service

Within the first 30 days from the original DOP, BAS will provide a return shipping label for any defective product shipped from within the 50 US States. After the first 30 days you are responsible for the freight charges incurred to send the product back to BAS. To send a product in for warranty service you will need the following:

- A Return Authorization number (RA#). Please contact our Customer Service to receive a RA#.
- A legible copy of the proof-of-purchase with your name, the name of the authorized dealer, the DOP and the model number of the product requiring service.
- Enclose a note stating the problem or issues with the product, your daytime phone number, email and return shipping address (within the USA, no P.O. Box please).

This warranty does not cover any product subjected to abuse, neglect, incorrect wiring, water or physical damage or any attempt to repair or modify the product by anyone other than an BAS Repair Technician. Any damages, resulting from legal action for breach of expressed or implied warranty shall be limited to the cost of the original purchase price of the product. All liability for coincidental damages are excluded under this warranty. The Customer agrees to retain the original proof-of-purchase for establishing the effective date of this warranty. If BAS or an Authorized Dealer replace your product under warranty, the replacement product shall be considered a transaction under the original warranty, and does not extend the original warranty period.

FOLD HERE

0716

To register this product fill-in this form and mail this card to the address shown on the reverse side.
For online registration, see reverse side of this card for instructions.

NAME

AGE

ADDRESS

CITY

STATE

ZIP

E-MAIL

PHONE

MODEL NO.

DATE OF PURCHASE

PURCHASE PRICE

PURCHASED FROM

INSTALLED BY

SERIAL NUMBER (If applicable)

VEHICLE: YEAR, MAKE AND MODEL



3451 Lunar Court • Oxnard, CA 93030

Customer Service:

US Toll-free: 1-800-999-1236

US Local Main: 1-805-988-0192

ONLINE: www.bosssaudio.com/support/technical-support



ONLINE PRODUCT REGISTRATION:

Scan this QR Code with your smart device, fill-in the online form to register your product. Or fill-in the online form by visiting: www.bosssaudio.com/support/warranty-registration

We hope you are enjoying your new BOSS Audio Systems product. We are always working to improve our products and provide a great customer experience. We welcome your feedback. Please consider writing a review for your new product on our website. We look forward to hearing about your experience.

FOLD HERE

PLACE
POSTAGE
HERE



3451 Lunar Court
Oxnard, CA 93030



MOBILE VIDEO PRODUCTS 2 YEAR WARRANTY EXTENSION

BOSS AUDIO SYSTEMS (BAS) will extend the original manufacturer 1 YEAR LIMITED WARRANTY for an additional 2 years if the unit is installed by an Authorized Dealer. The additional 2 YEAR EXTENDED WARRANTY will cover the parts and labor to repair or replace the unit. All other conditions of the original Limited Warranty applies.

Obtain Warranty Service

Customer is responsible for freight charges incurred to send unit back to BAS after the first 30 days from original date of purchase. To send a product in for warranty service you will need the following:

- A Return Authorization number (RA#). Please contact our Customer Service to receive a RA#.
- A legible copy of the proof-of-purchase with your name, the name of the authorized dealer, the DOP and the model number of the product requiring service.
- Enclose a note stating the problem or issues with the product, your daytime phone number, email and return shipping address (within the USA, no P.O. Box please).

This warranty does not cover any product subjected to abuse, neglect, incorrect wiring, water or physical damage or any attempt to repair or modify the product by anyone other than an BAS Repair Technician. Any damages, resulting from legal action for breach of expressed or implied warranty shall be limited to the cost of the original purchase price of the product. All liability for coincidental damages are excluded under this warranty. The Customer agrees to retain the original proof-of-purchase for establishing the effective date of this warranty. If BAS or an Authorized Dealer replace your product under warranty, the replacement product shall be considered a transaction under the original warranty, and does not extend the original warranty period.

www.bossaudio.com

Customer Service: www.bossaudio.com/support/technical-support

US Toll-free: 1-800-999-1236

US Local Main: 1-805-988-0192



THANK YOU

from **BOSS AUDIO SYSTEMS**
FOR YOUR PURCHASE

There's a reason we have been a leader and innovator
in the business since 1987.

Our goal is for you to be completely satisfied with your purchase.

If for any reason you are unsatisfied, please let us
be the first to know.

Contact our Customer Care dept. at 805.988.0192

WE WANT YOUR POSITIVE FEEDBACK AND REVIEWS!

www.bossaudio.com

PLEASE WRITE A REVIEW on
Amazon.com and BOSSaudio.com



Like us on **Facebook!**



SHARE YOUR
BOSS Audio Systems photos and videos
on our website and Facebook!

WIN PRIZES!